

Engineering progress
Enhancing lives

RAUPANEL™ product instructions

Product instructions for REHAU RAUPANEL radiant heating panel system for use in hydronic heating applications. na.rehau.com/resource-center



SCOPE

This guide provides technical instruction regarding the installation of RAUPANEL radiant heating systems. RAUPANEL may only be installed by an appropriately licensed installer of radiant heating systems.

Design considerations are not covered. This guide assumes the installer has already been provided with a REHAU radiant heating system design or approved equivalent in accordance to the REHAU *Radiant Heating Systems Design Guide*.

The installation of RAUPEX® pipe used in the RAUPANEL radiant heating system must be in accordance with these instructions and the REHAU *Radiant Heating Systems Installation Guide*. These instructions do not supersede the recommendations of other manufacturers. If there is conflicting information, the installer must consult with the other manufacturer's representative prior to installing and connecting the RAUPANEL system.

-  This symbol and the signal words DANGER, WARNING or CAUTION alert you to personal injury hazards. If you don't avoid the hazardous situation:
- DANGER! Will result in death or serious injury
 - WARNING! Could result in death or serious injury
 - CAUTION! Can result in minor or moderate injury

The signal word NOTICE is used to help you avoid property damage. We cannot warn of all hazards; you must also use your own good judgment.

ABOUT RAUPANEL HIGH-PERFORMANCE RADIANT HEAT TRANSFER PANELS

Heat transfer panels are used in radiant floor, wall and ceiling heating systems to efficiently and evenly distribute the heat from REHAU's RAUPEX pipe into the room. Typically, heat transfer panels are installed between the subfloor and the finished floor. Walls and ceilings may be used as heating surfaces to increase the heat output into a room. In these applications, panels are installed between the wall studs or joists and the wall or ceiling covering respectively. Note the following:

- Heat transfer panels are not a structural component of the building and do not contribute to the load carrying capacity of the floor.
- RAUPANEL system components must be stored in a dry location. To avoid denting or damaging the panels, store in a location with minimal traffic. Do not stack heavy materials on top of the RAUPANEL components.
- Using asphalt felt as an underlayment and/or vapor retarder can cause a short-term odor when the radiant heat is first turned on.
- Do not nail, staple or screw through the pipe.
- Most finished coverings have a specific temperature limit. Floor, wall and ceiling coverings can be damaged by excessive temperatures leading to discoloring, noise, delaminating, warping, cracking and deterioration of the finished coverings.
- The installer and building owner must ensure ground water and water vapor issues will not be responsible for damaging other building elements such as the RAUPANEL components or causing problems to floor coverings installed after the construction of the building.
- The RAUPANEL system must be installed with REHAU RAUPEX O₂ barrier pipe. Installation of pipe supplied by any other manufacturer is not recommended and may cause noise issues.

RAUPANEL radiant heating systems may be installed to a wood subfloor over joists, a wood subfloor over a slab, to wall studs and ceiling joists, and directly over an existing slab. The system is easy to design and install around special conditions to optimize thermal comfort and

increase energy efficiency. RAUPANEL may be installed during new construction or as a retrofit system. For new construction, installing the RAUPANEL system at a late stage, for example after drywalling, has been successful for many installations.



Fig. 1: Installing RAUPANEL to wood subfloor over joists



Fig. 2: Installing RAUPANEL to steel wall studs



Fig. 3: Installing RAUPANEL directly above an existing slab



Fig. 4: Installing RAUPANEL through a doorway



Fig. 5: Installing RAUPANEL with complex piping layouts



Fig. 6: Installing RAUPANEL with warmest water to the perimeter (an exterior door) then to the occupied (interior) areas of a room

System Components

The RAUPANEL system is comprised of:

- Aluminum panel
- Furring strip
- Return bend 6 in. on-center (OC)
- Return bend 8 in. OC
- 3/8 in. RAUPEX O₂ barrier PEXa pipe
- Manifold connectors
- Support bends (optional)
- Protection sleeves (optional)
- EVERLOC+® compression-sleeve fitting and tools (if required to repair pipe)

Installer May Also Need:

- Specific fasteners (not provided by REHAU)
- Appropriate underlayment (if required)
- Radiant heating system design and piping layout pattern
- Electric saw with carbide-tipped fine-tooth cutting blade (suitable for cutting both wood and aluminum)
- Deburring tool or equivalent
- Cordless drill with screwdriver bit and drill bits
- Chalk line, pencil, framing square, tape measure
- Vacuum
- Extension cord
- PEX pipe cutter
- Chisel, hammer and rubber mallet
- Safety glasses (required)
- Hearing protection (required)
- Work gloves (recommended)
- Pipe uncoiler (optional)
- Router with 1/2 in. round nose bit (optional)

Technical Details

Component Specifications	Materials
aluminum panels	extruded aluminum
return bends and furring strips	machined plywood

Additional Specifications

- Component height 5/8 in (15.9 mm)
- Plywood panels have low formaldehyde emission levels; they meet or are exempt from most formaldehyde emission standards and regulations

Installation Overview

The following sequence is the most efficient way to install the RAUPANEL radiant heating system.

1. Gather documents
2. Prepare jobsite
3. Install felt underlayment to OSB subfloor, if required
4. Install manifold
5. Insulate walls/ceilings, if required
6. Position and align RAUPANEL components
7. Install pipe, starting and ending each circuit at manifold
8. Fasten RAUPANEL components, if required
9. Fasten finished flooring underlayment, if required
10. Pressure test
11. Insulate below subfloor, if required
12. Install finished covering to floor, wall or ceiling

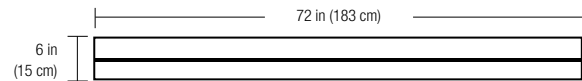

Aluminum Panel

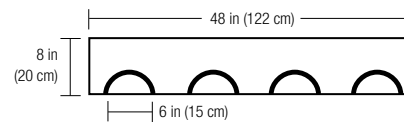

Return Bend 6 in. On-center

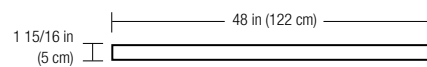

Furring Strip

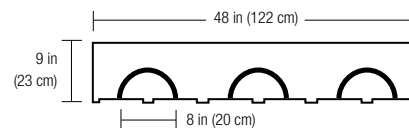

Return Bend 8 in. On-center

Fig. 7: Panel dimensions (not to scale)

APPLYING RAUPANEL TO WOOD SUBFLOOR

This section applies to installing components to both a wood subfloor over suspended wood frame construction or a wood subfloor over a slab. An installation in a simple square room is described below. Skilled installers will adapt these instructions for complex room layouts.

1. Gather the necessary documents and specifications before beginning a radiant installation:

- radiant heating system design
- piping layout or pattern
- building drawings
- pertinent REHAU technical guidelines

2. Ensure site conditions are suitable for the installation of heat transfer panels (i.e., clear space to work and plywood or OSB subfloor that is flat, even, level, structurally sound, dry, silent and free of debris).

Correct any discrepancies before starting the installation.

Follow all manufacturer's instructions for installing over plywood or OSB subflooring.

Confirm that the additional floor height due to the 5/8 in. thick RAUPANEL components has been taken into account. Door frames, base plates, moldings, electrical outlets, etc. may need to be raised. Doors and thresholds may need to be modified.

Check that the orientation of the panels is the preferred orientation. The following factors may be important:

- aluminum panels should be installed perpendicular to nail-down solid hardwood flooring to improve the ease of installation of this finished flooring and minimize chances of flooring installers damaging the pipe.
- aluminum panels should be installed in the direction of the longest room dimension to minimize the number of bends required, thus maximizing the pipe runs, and improving the ease of installation.

Verify that the pipe layout pattern and the panel orientation are properly designed for the as-built site conditions. If necessary, revise the design before starting the installation.

Check that the planned circuit lengths are not excessive. RAUPEX 3/8 in. pipe circuits typically should not exceed 250 ft (75 m) in length depending on flow and output requirements. Generally, REHAU recommends that these circuit lengths (including supply and return tails) be kept below 200 ft (60 m) to help minimize pump size and attain high system efficiencies.

Check that the planned finished floor coverings are per the design.

Note: System performance might not be attained if the insulation values of the floor coverings have not been taken into account.

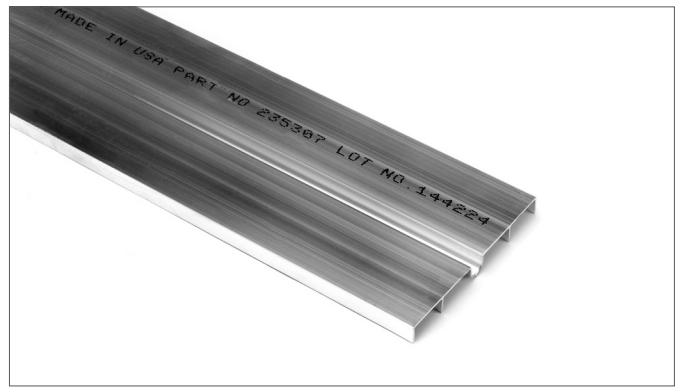

Fig. 8: Aluminum heat transfer panel

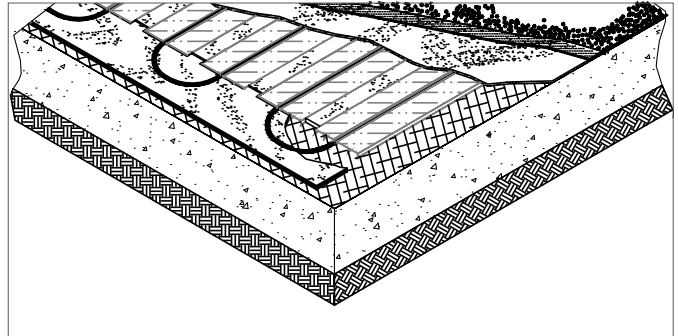

Fig. 9: Furring strip



Fig. 10: Return bend heat transfer panel for 6 in. on-center pipe spacing



Fig. 11: Return bend heat transfer panel for 8 in. on-center pipe spacing

3. When installing RAUPANEL over OSB subflooring, REHAU recommends applying a non-asphalt synthetic felt between the OSB subflooring and RAUPANEL. By following proper installation practices and observing all manufacturers' recommendations, noise during heating system operation can be minimized. Heat transfer panels are quieter than many other heating systems, but no one can ever guarantee that a heated floor will be noise free. See REHAU *Technical Bulletin 257*.

4. Install the PRO-BALANCE® manifold per the REHAU *PRO-BALANCE Manifold Product Instructions*. If the design does not specify the manifold location or changes are necessary for the as-built site conditions, then refer to the manifold product instruction and the *REHAU Radiant Heating System Design Guide* for directions on manifold placement and installation.

5. Plan the paths for the pipe circuit tails to the area they will serve. It may be helpful to mark the floor where the tails will be installed. Tails may be located using any of the following methods:

- run tails into a wall by notching the baseplate
- run tails into a suspended subfloor by drilling a 45° angled hole in the subfloor and passing pipe through
- run tails on top of the subfloor by either routing 1/2 in. grooves in nominal 5/8 in. (nom. 15.5 mm) plywood filler, then press the pipes into the grooves or use furring strips with pipes fastened in between

Mark all penetrations in the floor, joists and base plates for the supply and return tails according to the design, making necessary corrections for the as-built site conditions. Coordinate with other trades so that any floor penetrations and obstructions can be clearly identified prior to installing the panels. Electrical outlets and fixtures within the floor must be clearly marked prior to RAUPANEL installation.

⚠ WARNING! Improper grounding may result in electrical shock and/or fire. Do not use aluminum panels to provide an electrical ground.

6. Place the return bends and furring strips at the wall edges. Ensure the layout is square. This may be achieved by snapping a chalk line offset from the wall where the header row will be installed. Mark additional chalk lines on the perpendiculars for the return bends. The system might be easier to install if the return bends and header row of furring strips are secured with only 2 screws in case adjustments are necessary; additional fasteners will be added later.

Check that return bends are properly placed. Pipe must not loop back (crossover) onto itself.

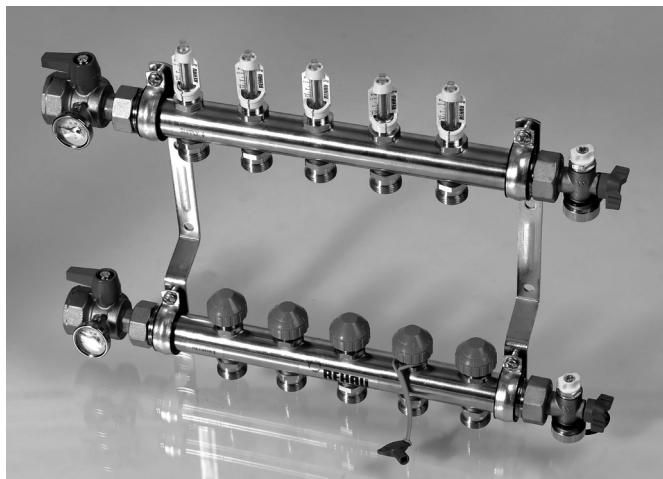

Fig. 12: PRO-BALANCE manifold



Fig. 13: Layout of furring strips and return bends at wall edges

Recommend leaving at least a 1/4 in (6 mm) offset between the wall edges and the RAUPANEL components to make it easier to install the layout and to allow for expansion/contraction of the building. Recommend at least a 3/4 in (18 mm) offset if the walls are unfinished.

Fasteners must screw through the panels and secure into the subfloor. Unless otherwise specified, recommend course-thread flat-head screws that are 1 1/2 in (40 mm) long when installing to a suspended wood subfloor. When installing to a floating wood subfloor over a slab, shorter fasteners might be required. Fasteners should be flush or slightly below the top surface of the RAUPANEL components for the proper installation of the floor covering.

To make square cuts, use an electric miter saw or equivalent.

⚠ CAUTION! Always wear safety glasses and hearing protection while cutting components to prevent injury. Always wear safety glasses and work gloves when handling and installing components and deburring aluminum panels to prevent injury.

7. Layout the aluminum panels. Cut components to length as required. For 6 in. on-center installations, recommend staggering the ends of the aluminum panels as they are placed into position. For 8 in. on-center installations, install furring strips between aluminum panels.

Leave 1/16 to 1/8 in (1.5 to 3 mm) gaps at ends of aluminum panels to accommodate for floor movement or shrinkage or other expansion/contraction movement.

After cutting, use the deburring tool, or equivalent, to remove sharp burrs on the inside of the aluminum panel pipe groove to prevent scratching the pipe.

8. If the planned layout pattern requires routing pipe grooves in 5/8 in. plywood filler for the tails, then this should be completed and installed now.

9. Inspect the layout of panels to ensure pipe grooves are sufficiently aligned. Adjust panels as needed. If necessary to prevent sharp edges from contacting the pipe, use a chisel to shave plywood corners at the transitions between return bends and aluminum panels.

Check for noise as the radiant heating system is installed and address concerns immediately rather than waiting until the end.

10 Install the pipe. See section INSTALLING PIPE INTO RAUPANEL.

11. Install plywood pieces as filler around the tails if the layout pattern calls for this.



Fig. 14: Layout of aluminum panels and alternating furring strips for 8 in. on-center



Fig. 15: Install pipe by stepping into groove with sole of work boot



Fig. 16: Deburring sharp edges

12. Secure the RAUPANEL components to the subfloor depending on the finished floor to be installed. Recommend coarse-thread flat-head screws or ring shank nails. For full length panels, use a minimum of 6 fasteners per aluminum panel, 8-9 fasteners per return bend and 5 fasteners per furring strip.

For full-length aluminum panels, use at least 3 fasteners each side. Pre-drilling aluminum panels before installing screws can make fastening easier, but some screws may be started without pre-drilling. Fasteners should be installed roughly 1/2 in (1 cm) from the outside edges to avoid changing the shape of the pipe groove. Fasteners must be countersunk into the aluminum panel leaving a flush top surface for installing the floor covering.

For tile, carpet, vinyl and linoleum flooring an appropriate underlayment must be installed according to the instructions of the floor covering manufacturer. A typical underlayment for carpet, vinyl and linoleum is plywood. A typical underlayment for tile is cement board.

When installing tile, carpet, vinyl and linoleum directly over a plywood underlayment and tile over cement board underlayment then:

- Allow the aluminum panels, return bends and furring strips to float without fasteners as these will be secured in a later step.
- Position the appropriate underlayment over top the RAUPANEL system. Best practice is to stagger the placement of the underlayment sheets so that four corners never meet.
- Transfer the location of the pipe to the top of the underlayment with a pencil, marker or chalk line before securing the underlayment to avoid damaging the RAUPEX pipe later in the installation.
- Recommend air testing the pipe circuit(s) before securing the underlayment. See section PRESSURE TESTING THE SYSTEM.
- Fully secure the underlayment with screws or nails that go through the RAUPANEL components and into the subfloor. Follow floor covering manufacturer guidelines and industry best practice for fastener spacing when securing the perimeter and interior of the underlayment. Fastener spacing should be approximately every 10-12 in. (25-30 cm). Use fasteners of appropriate length to ensure the underlayment is properly secured to the subfloor. Fasteners must be countersunk into the underlayment leaving a flush top surface for installing the floor covering.

NOTICE: Do not nail or screw through the pipe when installing the panels or the underlayment. Damaged pipe may leak, causing system failure and property damage.

When installing engineered wood flooring, laminated wood flooring, floating wood flooring, tile over mud bed, and tile over isolation mat/membrane then:

- Fully secure the aluminum panels, return bends and furring strips to the subfloor with screws or nails.

When installing nail-down solid hardwood flooring then:

- Fully secure the plywood return bends and furring strips to the subfloor with screws or nails.
- Allow the aluminum panels to float without fasteners.



Fig. 17: Grooves custom-routed in plywood for supply and return tails

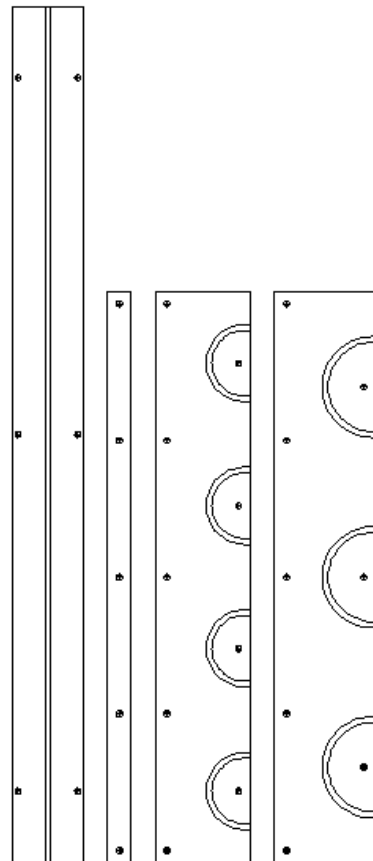

Fig. 18: Recommended fastener locations ⊕, if required

13. Test the system before and during installation of the finished flooring. See section PRESSURE TESTING THE SYSTEM.

NOTICE: The pressure test should be repeated during the installation of the finished floor coverings. Fasteners that contact or penetrate the pipe may damage the pipe resulting in leaks and operational failure. Should pipe become punctured or cut, the section of damaged pipe must be replaced. See sub section REPLACING DAMAGED PIPE IN HEAT TRANSFER PANELS.

14. Insulate under the subfloor, if appropriate.

The directional efficiency of the aluminum panel profile conducts heat across the top panel surface and to the finished floor above with minimal downward heat transfer (reverse loss). The radiant heating system design might not require subfloor insulation over a heated space, when allowed by local codes, which saves time and materials.

In some cases compliance to local codes, thermal comfort of the room occupants, proper operation of the system, fastest response time, sound abatement and the most efficient use of energy are compelling reasons to insulate underneath the subfloor. When installing insulation to the underside of the subfloor, an air gap between the insulation and the subfloor is not required. Always follow local codes to ensure compliance with insulation minimums. Recommend insulation of R-19 above heated spaces and R-30 above unheated spaces to direct heat upward.

15. Install floor covering. See section INSTALLING FLOOR, WALL AND CEILING COVERINGS OVER RAUPANEL.

These are general guidelines for installing RAUPANEL under commonly encountered floor covering scenarios. For a specific project the installer must work with other trades, including the installer of the subfloors and finished floors, to ensure adherence to the flooring manufacturer's requirements.

NOTICE: Always follow the specific flooring manufacturer's installation instructions. Failure to do so may lead to squeaky or noisy floors.

Address any noise concerns before installing the finished flooring by installing additional fasteners.

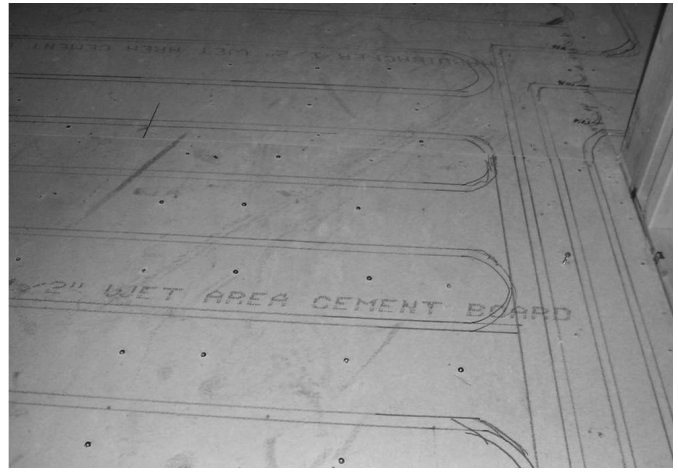

Fig. 19: Mark pipe locations before securing underlayment over RAUPANEL to subfloor (if required)

APPLYING RAUPANEL TO WALL STUDS OR CEILING WOOD JOISTS

This section applies to wood wall studs and wood ceiling joists. A simple rectangular wall installation is described below. Skilled installers will adapt these instructions for complex wall and ceiling layouts.

1. Gather the necessary documents and specifications before beginning a radiant installation:

- radiant heating system design
- piping layout or pattern
- building drawings
- pertinent REHAU technical guidelines

2. Ensure site conditions are suitable for the installation of heat transfer panels (i.e., clear space to work and studs and/or joists that are straight, evenly spaced, structurally sound, dry, silent and free of debris). Correct any discrepancies before starting the installation. Install additional studs and blocking if necessary to ensure adequate nailing surfaces for the heat transfer panels.

Verify that the pipe layout pattern and the panel orientation are properly designed for the as-built site conditions. The panels and pipe should be installed perpendicular to studs and joists. If necessary, revise the design before starting the installation.

Check that the planned circuit lengths are not excessive. RAUPEX 3/8 in. O₂ Barrier pipe circuits typically should not exceed 250 ft (75 m) in length depending on flow and output requirements. Generally, REHAU recommends that these 3/8 in. pipe circuit lengths (including supply and return tails) be kept below 200 ft (60 m) to help minimize pump size and attain high system efficiencies.

3. Insulate the wall/ceiling and install vapor barrier, if required, before installing RAUPANEL. Install with no air gap between the insulation and the backside of the RAUPANEL. Always follow local codes to ensure compliance with insulation minimums.

4. Install the PRO-BALANCE manifold per the REHAU *PRO-BALANCE Manifold Product Instructions*. If the design does not specify the manifold location or changes are necessary for the as-built site conditions, then refer to the manifold product instruction and the REHAU *Radiant Heating System Design Guide* for directions on manifold placement and installation.

5. Plan the paths for the circuit tails to the area they will serve. It may be helpful to mark the path where the tails will be installed. Tails may be located using any of the following methods:

- run tails through walls sleeving pipe at joist penetrations
- run tails through base plate and under suspended subfloor, sleeving pipe at floor penetrations
- integrate tails into a floor circuit by transitioning through a notch in the baseplate

Mark all penetrations in the walls, ceiling and floor for the supply and return tails according to the design, making necessary corrections for the as-built site conditions. Coordinate with other trades so that any floor penetrations and obstructions can be clearly identified prior to installing the panels.

Electrical outlets and fixtures within the wall must be clearly marked prior to RAUPANEL installation.

⚠ WARNING! Improper grounding may result in electrical shock and/or fire. Do not use aluminum panels to provide an electrical ground.

6. Install a first header row of aluminum panels or furring strips with 2 screws starting near the floor and ensuring the panel is level. This may be achieved by snapping a level chalk line. Cut components to length as required. To make square cuts, use a miter saw or equivalent.

Unless otherwise specified, recommend course thread screws 2 in. (50 mm) long. Fasteners must screw through the components and securely into the stud and/or joist.

Leave 1/16 to 1/8 in (1.5 to 3 mm) gaps at ends of aluminum panels to accommodate wall/ceiling movement or shrinkage.

After cutting, use the deburring tool, or equivalent, to remove sharp burrs on the inside of the aluminum panel pipe groove to prevent scratching pipes.

⚠ CAUTION! Always wear safety glasses and hearing protection while cutting components to prevent injury. Always wear safety glasses and work gloves when handling and installing components and deburring aluminum panels to prevent injury.

7. Install the return bends at the ends of the layout with two screws each. The system may be easier to install if the return bends and header row are secured with only 2 screws in case adjustments are necessary; additional fasteners will be added later.

Check return bends are properly placed for continuous pipe patterns.

8. Install the additional rows of aluminum panels or alternating aluminum panels and furring strips.

9. Inspect the layout to ensure pipe grooves are sufficiently aligned. Adjust components as needed. If necessary to prevent sharp edges from contacting the pipe, use a chisel to shave plywood corners at the transitions between return bend and aluminum panels.

10. Fully secure all components at each stud or joist. Use coarse-thread screws or ring-shank nails. Pre-drilling aluminum panels before installing screws can make fastening easier, but some screws may be started without pre-drilling. Fasteners should be installed roughly 1/2 in (1 cm) from the outside edges of the aluminum panel to avoid changing the shape of the pipe groove. Fasteners must be countersunk leaving a flush top surface for installing the wall or ceiling covering.

11. Install the pipe. See section INSTALLING PIPE INTO RAUPANEL.

12. Recommend installing stud guard steel protectors over pipes where they cross studs and joists to prevent accidental pipe damage by other trades or building occupants.

13. When RAUPANEL is installed over only part of a wall or ceiling, then install furring strips to the remaining studs and joists as required to create a level surface to install the wall or ceiling covering.

14. Test the system before and during installation of the finished coverings. See section PRESSURE TESTING THE SYSTEM.

NOTICE: The pressure test should be repeated during the installation of the finished floor coverings. Fasteners that contact or penetrate the pipe may damage the pipe resulting in leaks and operational failure. Should pipe become damaged, the section of damaged pipe must be replaced. See sub section REPLACING DAMAGED PIPE IN HEAT TRANSFER PANELS.

15. Install wall and ceiling coverings. See section INSTALLING FLOOR, WALL AND CEILING COVERINGS OVER RAUPANEL.



Fig. 20: Typical installation with tails routing into floor circuit

APPLYING RAUPANEL ABOVE A SLAB

This section applies to installing components to existing suspended, on-grade and below-grade concrete slabs. An installation in a simple square room is described below. Skilled installers will adapt these instructions for complex room layouts.

The addition of a plywood subfloor over the concrete may be preferred. See section CONSTRUCTING WOOD SUBFLOOR OVER SLAB, then install the RAUPANEL system in accordance to the section APPLYING RAUPANEL TO WOOD SUBFLOOR. Otherwise, for RAUPANEL installations anchored to a concrete slab, following the instructions below.

1. Gather the necessary documents and specifications before beginning a radiant installation:

- radiant heating system design
- piping layout or pattern
- building drawings
- pertinent REHAU technical guidelines

2. Ensure site conditions are suitable for the installation of heat transfer panels (i.e., clear space to work and slab that is flat, even, level, free of debris, dry and must stay sufficiently dry). Correct any discrepancies before starting the installation.

Confirm that the additional floor height due to the 5/8 in. thick RAUPANEL has been taken into account. Door frames, base plates, moldings, electrical outlets, etc. may need to be raised. Doors and thresholds may need to be modified.

Verify that the pipe layout pattern and the panel orientation are properly designed for the as-built site conditions. If necessary, revise the design before starting the installation.

Check that the planned circuit lengths are not excessive. RAUPEX 3/8 in. pipe circuits typically should not exceed 250 ft (75 m) in length depending on flow and output requirements. Generally, REHAU recommends that 3/8 in. pipe circuit lengths (including supply and return tails) be kept below 200 ft (60 m) to help minimize pump size and attain high system efficiencies.

Check that the orientation of the panels is the preferred orientation.

The following factors may be important:

- aluminum panels should be installed perpendicular to nail-down solid hardwood flooring to improve the ease of installation of this finished flooring and minimize chances of flooring installers damaging the pipe.
- aluminum panels should be installed in the direction of the longest room dimension to minimize the number of bends required, thus maximizing the pipe runs, and improving the ease of installation.

Check that the planned finished floor coverings are per the design.

Note: System performance might not be attained if the insulation values of the floor coverings have not been taken into account.

3. Install the PRO-BALANCE manifold per the REHAU

PRO-BALANCE Manifold Product Instructions. If the design does not specify the manifold location or changes are necessary for the as-built site conditions, then refer to the manifold product instruction and the REHAU *Radiant Heating System Design Guide* for directions on manifold placement and installation.

4. Plan the paths for the pipe circuit tails to the area they will serve. It may be helpful to mark the floor where the tails will be installed. Tails may be located using any of the following methods: – run tails into a wall by notching the baseplate – run tails on top of the slab by routing 1/2 in. grooves into nominal 5/8 in (nom. 15.5 mm) plywood filler, then press the pipes into the grooves or use furring strips with pipe fastened in between - run tails through the aluminum panels

Mark all penetrations in the floor, joists and base plates for the supply and return tails according to the design, making necessary corrections for the as-built site conditions. Coordinate with other trades so that any floor penetrations and obstructions can be clearly designated prior to installing the panels. Electrical outlets and/or fixtures within the floor must be clearly marked prior to RAUPANEL installation.

⚠ WARNING! Improper grounding may result in electrical shock and/or fire. Do not use aluminum panels to provide an electrical ground.

5. Install 3 mil polyethylene (PE) or other type of approved vapor barrier covering the entire area and the adjacent wall edges up to the top of the baseplate to prevent moisture from permeating through the slab and contacting the RAUPANEL components. The installer is responsible for ensuring the moisture conditions will not damage the RAUPANEL components or the floor coverings.

6. Install the return bends and furring strips at the wall edges. Ensure the layout uses square corners (right angles). This may be achieved by snapping a chalk line offset from the wall where the header row will be installed. Mark additional chalk lines on the perpendiculars for the return bends.

Check that return bends are properly placed. Pipe must not loop back (crossover) onto itself.

Recommended leaving at least a 1/4 in (6 mm) offset between the wall edges and the RAUPANEL components to make it easier to install the layout and to allow for expansion/contraction of the building. Recommend at least a 3/4 in (18 mm) offset if the walls are unfinished to allow for drywall.

To make square cuts, use a miter saw or equivalent.

⚠ CAUTION! Always wear safety glasses and hearing protection while cutting components to prevent injury. Always wear safety glasses and work gloves when handling and installing components and deburring aluminum panels to prevent injury.

7. Layout the aluminum panels. Cut components to length as required. For 6 in. on-center installations, recommend staggering the ends of the aluminum panels as they are placed into position. For 8 in. on-center installations, install furring strips between aluminum panels.

Leave 1/16 to 1/8 in (1.5 to 3 mm) gaps at ends of aluminum panels to accommodate for floor movement or shrinkage or other expansion/contraction movement.

After cutting, use the deburring tool, or equivalent, to remove sharp burrs on the inside of the aluminum panel pipe groove to prevent scratching pipes.

8. If the planned layout pattern requires routing pipe grooves in 5/8 in. plywood filler for the tails, then this should be completed and installed now.

9. Inspect the layout of panels to ensure pipe grooves are sufficiently aligned. Adjust panels as needed. If necessary to prevent sharp edges from contacting the pipe, use a chisel to shave plywood corners at the transitions between return bends and aluminum panels.

Check for noise as the radiant heating system is installed and address concerns immediately rather than waiting until the end.

10. Install the pipe. See section INSTALLING PIPE INTO RAUPANEL.



Fig. 21: Installing pipe by setting into groove with rubber mallet

11. Secure the RAUPANEL components to the subfloor depending on the finished floor to be installed. Recommend powder-actuated fasteners or split-drive anchors. For full length panels, use a minimum of 6 fasteners per aluminum panel, 8-9 fasteners per return bend, and 5 fasteners per furring strip.

For full-length aluminum panels, use at least 3 fasteners on each side. Fasteners should be installed roughly 1/2 in (1 cm) from the outside edges of the aluminum panel to avoid changing the shape of the pipe groove. Fasteners must be countersunk leaving a flush top surface for installing the floor covering.

For tile, carpet, vinyl and linoleum flooring an appropriate underlayment must be installed according to the instructions of the floor covering manufacturer. A typical underlayment for carpet, vinyl and linoleum is plywood. A typical underlayment for tile is cement board.

When installing tile, carpet, vinyl and linoleum directly over a plywood underlayment and tile over cement board underlayment then:

- Allow the aluminum panels, return bends and furring strips to float without fasteners as these will be secured in a later step.
- Position the appropriate underlayment overtop the RAUPANEL system. Best practice is to stagger the placement of the underlayment sheets so that four corners never meet.
- Transfer the location of the pipe to the top of the underlayment with a pencil, marker or chalk line before securing the underlayment to avoid damaging the RAUPEX pipe later in the installation.
- Recommend air testing the pipe circuit(s) before securing the underlayment. See section PRESSURE TESTING THE SYSTEM.
- Fully secure the underlayment with fasteners or anchors that go through the RAUPANEL components and into the slab. Follow floor covering manufacturer guidelines and industry best practice for the fastener spacing when securing the perimeter and interior of the underlayment. Fastener spacing should be approximately every 10-12 in. (25-30 cm). Use fasteners or anchors of appropriate length to ensure the underlayment is properly secured to the subfloor. Fasteners or anchors must be countersunk into the underlayment leaving a flush top surface for installing the floor covering.

NOTICE: Do not drill or nail through the pipe when installing the components or the underlayment. Damaged pipe may leak, causing system failure and property damage.

When installing nail-down solid hardwood flooring, engineered wood flooring, laminated wood flooring, floating wood flooring, tile over mud bed, and tile over isolation mat:

- Fully secure the aluminum panels, return bends and furring strips to the slab.

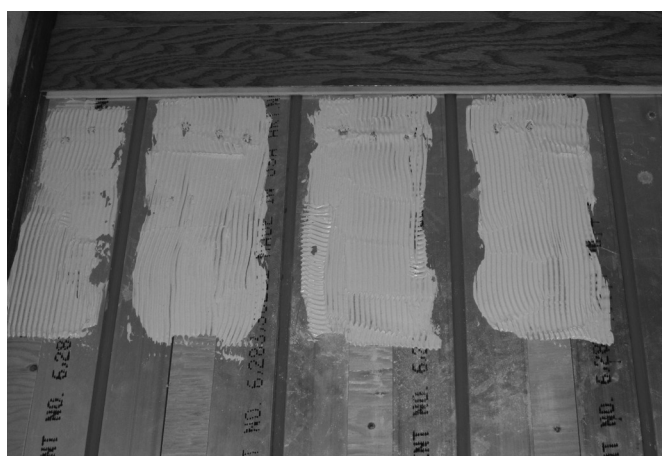

Fig. 22: Applying adhesive to RAUPANEL avoiding the pipes

12. Test the system before and during installation of the finished flooring. See section PRESSURE TESTING THE SYSTEM.

NOTICE: The pressure test should be repeated during the installation of the finished floor coverings. Fasteners that contact or penetrate the pipe may damage the pipe resulting in leaks and operational failure. Should pipe become damaged, the section of damaged pipe must be replaced. See sub section REPLACING DAMAGED PIPE IN HEAT TRANSFER PANELS.

13. For suspended slabs, insulate under the slab, if appropriate.

The directional efficiency of the aluminum panel profile conducts heat across the top panel surface and to the finished floor above with minimal downward heat transfer (reverse loss). The radiant heating system design might not require under slab insulation when the suspended slab is over a heated space, when allowed by local codes, which saves time and materials.

In some cases compliance to local codes, thermal comfort of the room occupants, proper operation of the system, fastest response time, sound abatement and the most efficient use of energy are compelling reasons to insulate underneath the suspended slab. When installing insulation to the underside of the suspended slab, an air gap between the insulation and the subfloor is not required. Always follow local codes to ensure compliance with insulation minimums. Recommend insulation of at least R-5 above heated spaces and unheated spaces to direct heat upward. R-value includes the resistance of the slab plus the additional insulation.

14. Install floor covering. See section INSTALLING FLOOR, WALL AND CEILING COVERINGS OVER RAUPANEL.

These are general guidelines for installing RAUPANEL under commonly encountered floor covering scenarios. For a specific project, the installer must work with other trades, including the installer of the subfloors and finished floors, to ensure adherence to the flooring manufacturer's requirements.

NOTICE: Always follow the specific flooring manufacturer's installation instructions. Failure to do so may lead to squeaky or noisy floors.

Address any noise concerns before installing the finished flooring by installing additional fasteners.

CONSTRUCTING WOOD SUBFLOOR OVER SLAB

This section applies to existing suspended, on-grade and below-grade concrete slabs. If the job site conditions allow the additional height, fastening RAUPANEL to a new wood subfloor over top an existing slab is preferred to anchoring RAUPANEL directly into the existing concrete. The insulating value of the wood subfloor between RAUPANEL and the slab increases the system efficiency by reducing the reverse loss. Also, when securing the RAUPANEL or assembling a floating wood subfloor, screws/nails are less expensive and require less skill to install than concrete anchors and fasteners. Further, if a vapor barrier is required, the customer may desire a floating wood subfloor as there are no penetrations to the vapor barrier.

REHAU is providing general industry guidelines for installing a wood subfloor over concrete as an aid in communicating technical information to the engineer of record. The engineer of record shall be responsible for converting all necessary and available technical information into a construction specification that meets the functional and structural needs of the client, as well as complying with all applicable codes and local job site conditions.

Assembling Floating Wood Subfloor Over Slab

1. Use a vapor barrier underneath the plywood subfloor for below-grade and on-grade applications to prevent moisture from permeating through the slab and contacting the wood components. Follow flooring manufacturer's recommendations regarding the requirements of a vapor barrier for above-grade applications. Recommend vapor barrier of 3 mil (minimum) PE film unless otherwise specified.
2. Recommend floating floor material of two layers 3/8 in (9.5 mm) minimum CD exposure 1 (CDX) plywood in 4 x 8 sheets.
3. Place the first plywood layer without fastening, staggering joints between rows so four corners never meet. Leave 3/4 in (18 mm) gap between plywood at wall lines and vertical obstructions. Leave 1/8 in (3 mm) gap between sheets.
4. Place second plywood layer perpendicular or at 45° to the first layer, also staggering joints between rows so four corners never meet. Leave 3/4 in (18 mm) gap between plywood at wall lines and vertical obstructions. Leave 1/8 in (3 mm) gap between sheets.
5. Staple or staple and glue with construction adhesive the second layer to the first layer. Fasten 2 in (50 mm) in from the outside edges and at 6 in (150 mm) spacing around the perimeter. Fasten at 12 in (300 mm) interior spacing. Be careful not to penetrate the vapor barrier below.

Nailing-Down Wood Subfloor Over Slab

1. Use a vapor barrier underneath the plywood subfloor for below-grade and on-grade applications to prevent moisture from permeating through the slab and contacting the wood components. Follow flooring manufacturer's recommendations regarding the requirements of a vapor barrier for above-grade applications. Recommend vapor barrier of 3 mil (minimum) PE film unless otherwise specified.
2. Recommend subfloor material of one layer 5/8 in (15.5 mm) minimum CD exposure 1 (CDX) plywood in 4 x 8 sheets.
3. Install the plywood layer, staggering joints between rows so four corners never meet. Leave 3/4 in (18 mm) gap between plywood at wall lines and vertical obstructions. Leave 1/8 in (3 mm) gap between sheets.
4. Fasten 2 in (50 mm) in from the outside edges and at 6 in (150 mm) spacing around the perimeter. Fasten at 12 in (300 mm) interior spacing. Use anchors suitable for concrete application. Anchors to be installed according to manufacturer's instructions and recommendations such as specified length, drill size and/or shot load.

INSTALLING PIPE INTO RAUPANEL

1. If required by the pipe layout pattern, drill penetrations into the suspended wood subfloor for supply and return tails. Subfloor penetrations should be wide enough, a minimum of 1 in (25 mm), to accommodate the pipe and at a 45-degree angle from the floor to allow a smooth bend in the pipe.

2. Before installing the pipe, make sure the RAUPANEL surfaces and the grooves are free of debris and obstructions by vacuuming.

3. Recommend starting with the pipe on the uncoiler in the room where the circuit is being installed. From this circuit area, route the supply tail of pipe through the subfloor, joist and wall penetrations to the manifold. Recommend protecting pipe at floor and joist penetrations with isolating clamps, protection sleeving, bushings or support bends to minimize noise and to prevent sharp edges from damaging the pipe. Secure pipe under the subfloor with clamps or clips, if applicable. Connect supply tail to the correct manifold supply outlet according to the radiant heating design. Refer to the REHAU *PRO-BALANCE Manifold Product Instructions* for properly connecting pipe to the manifold.

4. Snap the pipe into the grooves of the aluminum panels and the return bends. Recommend stepping the pipe into the grooves with the stiff rubber sole of a work boot. If the pipe is not fully seated, check for any obstructions, then use a rubber mallet to hammer the pipe in place. Bends should be carefully formed to prevent kinking.

NOTICE: If pipe is not fully seated in the groove of the aluminum panels the pipe may cause noise.

NOTICE: Kinked pipe may result in obstructed or reduced flow and must be repaired. Should a pipe become kinked, see sub section REPAIRING KINKED PIPE IN HEAT TRANSFER PANELS.

5. Once the circuit is completed, route the return tail through the subfloor, joist and wall penetrations to the manifold. Secure pipe under the subfloor or in the wall/ceiling with clamps or clips if applicable. Recommend protecting pipe at floor and joist penetrations with isolating clamps, protection sleeving, bushings or support bends. Connect the return tail to the correct manifold return inlet that corresponds to the correct supply outlet. Refer to the REHAU *PRO-BALANCE Manifold Product Instructions* for properly connecting pipe to the manifold.



Fig. 23: Drilling subfloor penetrations for supply and return tails



Fig. 24: Snapping pipe into groove



Fig. 25: Typical floor installation with pipe installed and tails routing to manifold below floor

6. Complete the REHAU *PRO-BALANCE Manifold Circuit Chart* with the circuit starting and ending footages and calculate the circuit length. Check that actual length is within 10% of the planned circuit length in the radiant heating design.

Fig. 26: PRO-BALANCE manifold circuit chart

Repairing Kinked Pipe in Heat Transfer Panels

RAUPEX pipe is flexible and resists kinking even at temperatures below freezing. Should the pipe become accidentally kinked, it is possible to restore the pipe to its original shape. Refer to REHAU *Radiant Heating Installation Guide* for detailed instructions on repair of kinks in pipe.

Repaired RAUPEX pipe is stiffer and stronger than the original pipe. Do not re-bend the pipe in the same place. You may have to adjust fasteners and the circuit to avoid bending in the same place. If the kink occurs at a groove within a return bend and it is not possible to adjust the circuit, the kinked pipe needs to be cut out and replaced using EVERLOC+ couplings.

Replacing Damaged Pipe in Heat Transfer Panels

When a damaged pipe circuit cannot be easily replaced, it may be necessary to install an EVERLOC+ coupling and sleeves to remove the damaged section of pipe. If the damage is in the return bend, then it might not be possible to repair the pipe in the same spot. This might require two sets of repair couplings and sleeves and a short section of pipe so the repair fittings are located along a straight section rather than a curved section of layout pattern.

Remove the pipe from the aluminum panel groove in the affected area and cut it at the point of puncture. Cut the aluminum panel at least 3 in (75 mm) in both directions from the point of puncture. Since the coupling diameter is larger than the RAUPANEL component height, chisel a pocket in the subfloor for the EVERLOC+ joint. Assemble the coupling and sleeves. Refer to the REHAU *Radiant Heating Installation Guide* for detailed instructions on connecting two pipes. Re-insert the pipe into the groove. Cut and secure furring strips or plywood filler to fill in the empty space around the repair fitting.

PRESSURE TESTING THE SYSTEM

A pressure test must be performed on the system to ensure the RAUPEX pipes and connections are leak free. Local jurisdictions may have additional testing requirements.

The pressure test must be performed prior to and during the installation of the floor, wall and ceiling coverings. Typically, the system is filled with water and pressurized to 1.5 times the operating pressure or 100 psi (6.9 bar), whichever is greater. Refer to the REHAU *Radiant Heating Installation Guide* for instructions on performing the system purging and pressure testing.

NOTICE: If there is a chance that the water could freeze, use a pre-mixed water/glycol mixture when filling the system or perform an air test. Frozen pipes may burst resulting in leaks and operational failures.

INSTALLING FLOOR, WALL AND CEILING COVERINGS

REHAU is providing general industry practices for installing finished coverings over RAUPANEL. Finished floor, wall and ceiling coverings must be installed according to the manufacturer's instructions, local codes and best practices.

NOTICE: Do not nail, staple or screw into the RAUPEX pipe. Fasteners that contact or penetrate the pipe will damage the pipe resulting in leaks and operational failure.

Most finished coverings have a specific temperature limit. Verify products are approved for use with radiant heating systems. Confirm the finished coverings has been taken into account. If necessary, check radiant design surface temperatures are within limitations set by the manufacturer of the finished covering and associated underlayment, adhesives, compounds and grouts. Refer to the REHAU *Radiant Heating Systems Design Guide* for additional design assistance.

NOTICE: Floor, wall and ceiling coverings may be damaged by excessive temperatures leading to discoloring, noise, delaminating, warping, cracking and deterioration of the finished coverings.

When using adhesives with RAUPANEL, apply adhesives directly to the RAUPANEL components while avoiding contact with the pipe.

NOTICE: Do not allow adhesives to come in contact with the exterior or the interior of the RAUPEX pipe. Chemicals may damage the pipe resulting in leaks and operational failures.

Select appropriate adhesives based on the manufacturer's instructions, materials being bonded and the operating temperatures. Generic, common, typical thinset materials mixed with water are acceptable in contact with the pipe as these are comparable to the materials used in concrete and overpour construction methods. If using a modified thinset, any additives need to be checked with REHAU's engineering department to maintain the application-specific warranty.

NOTICE: Check compatibility before allowing chemicals to come in contact with the exterior or interior of the pipe. Chemicals may damage the pipe resulting in leaks and operational failures.

Gypsum Wall and Ceiling Board

Typical installation is to screw or nail gypsum board over the RAUPANEL. First, secure gypsum board through the RAUPANEL and into the studs, joists or blocking behind the panels. Recommend minimum 2 in (50 mm) long fasteners to ensure gypsum board is properly secured. Then join gypsum boards with joint tape and joint compound or other standard practice.

Tile Over Cement Board Underlayment

Typical installation is to apply cement boards over the RAUPANEL, then apply tile. First fasten underlayment through the RAUPANEL into the subfloor or slab, fill the seams in the cement board (if necessary), apply a layer of thinset, install tile and then grout. If using a leveling bed, recommend applying to the subfloor/slab and then install the RAUPANEL overtop, followed by the cement board, thinset then tile.

Tile Over Isolation Mat or Membrane Underlayment

Typical installation is to apply mat/membrane over the RAUPANEL, then apply tile. First, apply thinset to RAUPANEL, apply and properly seat isolation mat, apply another layer of thinset, install tile and grout.

Tile Over Mud Bed

Typical installation is to apply mud bed over the RAUPANEL, then apply tile. First install a suitable cleavage membrane, such as 3 mil PE film, over the RAUPANEL. Fasten metal lath over this membrane. Pour mortar onto metal lath. Pack and level to appropriate height and minimum thickness. Apply a layer of thinset, install tile and then grout.

Carpet, Vinyl or Linoleum Over a Plywood Underlayment

Typical installation is to apply an underlayment over the RAUPANEL, then apply carpet, vinyl or linoleum.

- For wall-to-wall carpet, first install tack strip around the wall edges, staple pad to underlayment and join seams, place carpet, seal carpet seams, stretch and secure carpet to tack strip. Ensure staples holding the pad are short enough they do not contact the pipe below the underlayment.
- For carpet tiles, vinyl and linoleum flooring, install using the appropriate adhesive to the underlayment.

Nail-down Solid Strip or Plank Hardwood Flooring

Typical installation is to apply hardwood flooring over the RAUPANEL. Ensure acceptable jobsite conditions, follow acclimation guidelines for installing hardwood flooring, follow hardwood installation instructions for the appropriate grade level (below, at or above grade) and ensure vapor barrier is correctly installed (if applicable). Nail, staple or cleat hardwood through RAUPANEL and into the subfloor. Fasten at regular intervals along the edge of the strip/plank as directed typically every 6 in (15 cm) for 6 in. pipe spacing and every 8 in (20 cm) for 8 in. pipe spacing layout patterns. Use minimum 2 in (5 cm) long fasteners to ensure hardwood is properly secured to the subfloor.

Engineered or Laminate Wood Flooring

The rapid development of engineered or laminate wood floor precludes the description of a typical installation. Follow all manufacturer's guidelines. If securing this wood flooring with adhesive, first apply adhesive directly to the RAUPANEL avoiding the pipe, then place the desired underlayment and flooring.

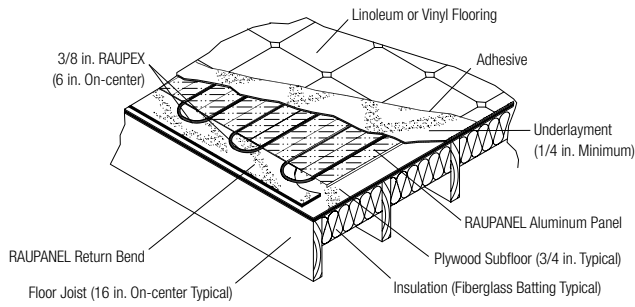

RAUPANEL 6 in. On-center Linoleum or Vinyl Flooring

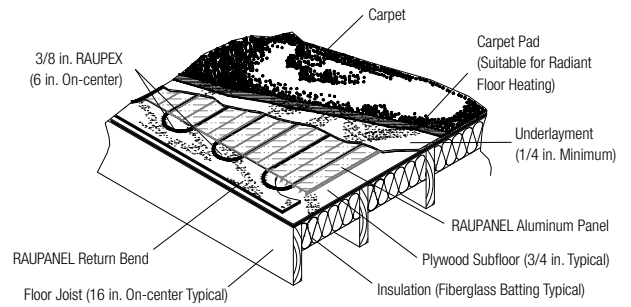

RAUPANEL 6 in. On-center Carpet

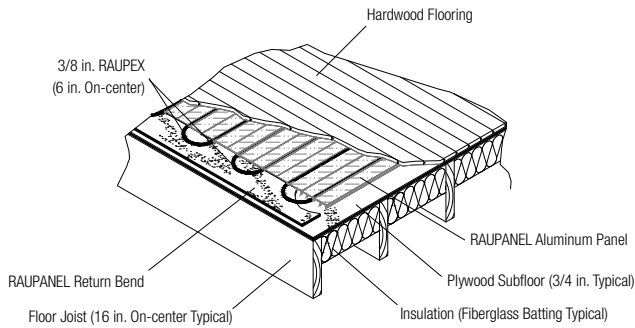

RAUPANEL 6 in. On-center Hardwood/Engineered Wood Flooring

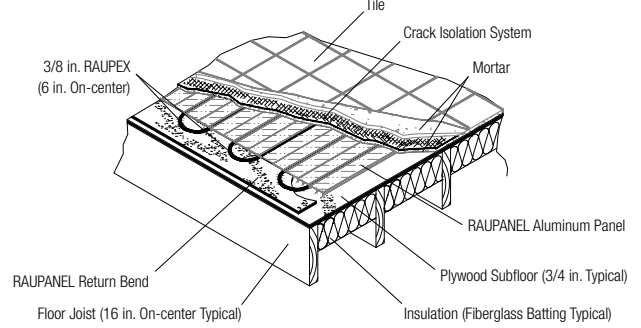

RAUPANEL 6 in. On-center Tile Flooring

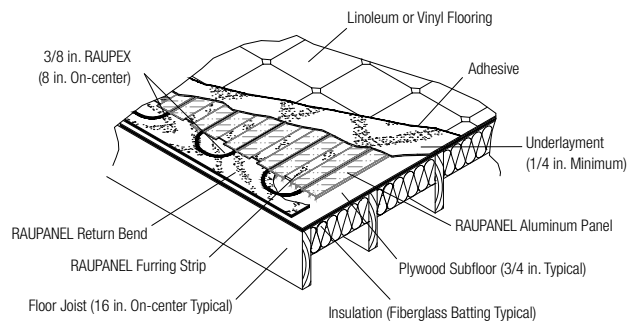

RAUPANEL 8 in. On-center Linoleum or Vinyl Flooring

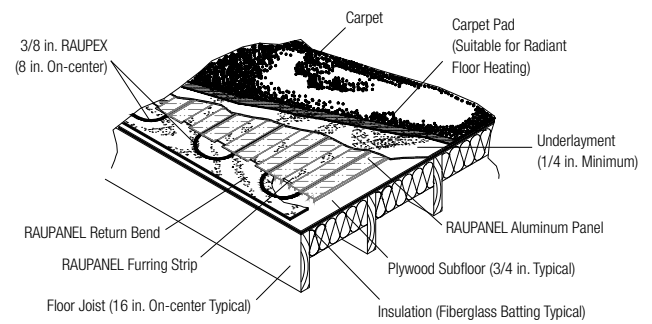

RAUPANEL 8 in. On-center Carpet

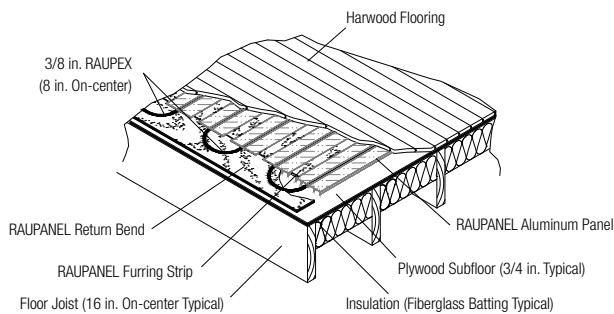

RAUPANEL 8 in. On-center Hardwood/Engineered Wood Flooring

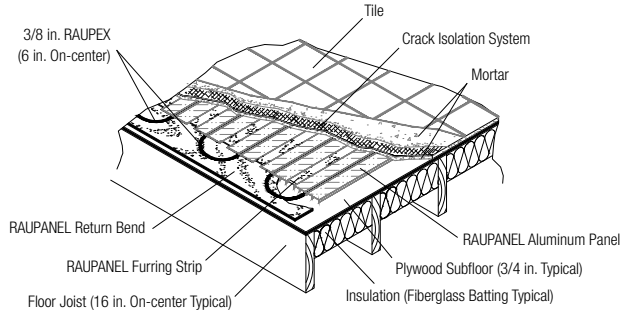

RAUPANEL 8 in. On-center Tile Flooring

Fig. 27: Typical finished floor assemblies over RAUPANEL applied to wood subfloor.

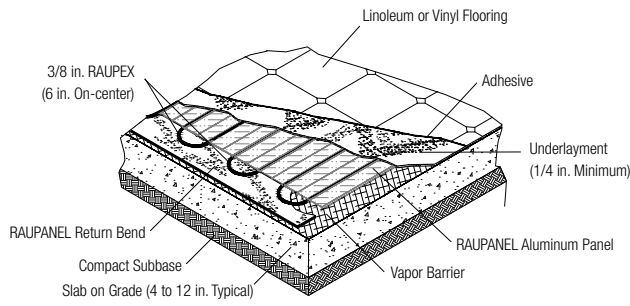

**RAUPANEL 6 in. On-center/Slab on Grade
Linoleum or Vinyl Flooring**

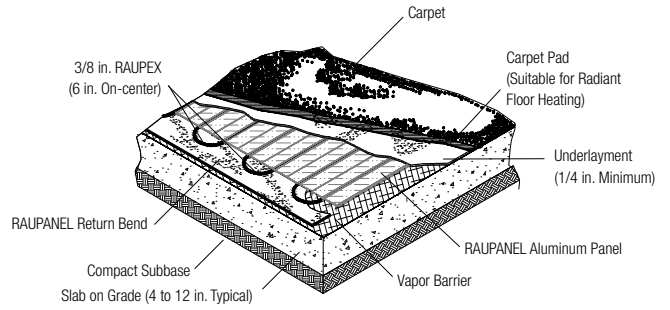

RAUPANEL 6 in. On-center/Slab on Grade Carpet

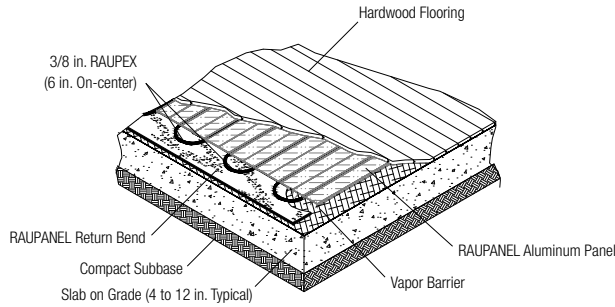

**RAUPANEL 6 in. On-center/Slab on Grade
Hardwood/Engineered Wood Flooring**

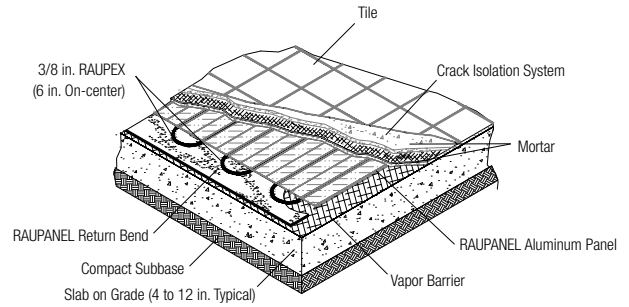

RAUPANEL 6 in. On-center/Slab on Grade Tile Flooring

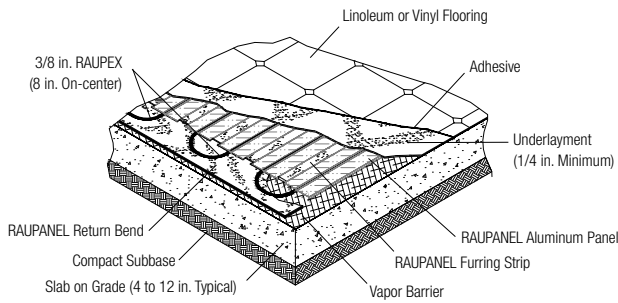

**RAUPANEL 8 in. On-center/Slab on Grade
Linoleum or Vinyl Flooring**

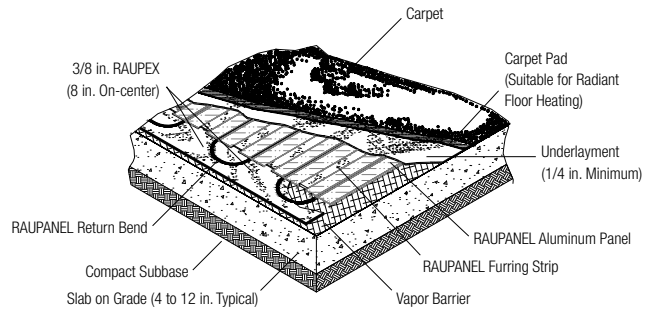

RAUPANEL 8 in. On-center/Slab on Grade Carpet

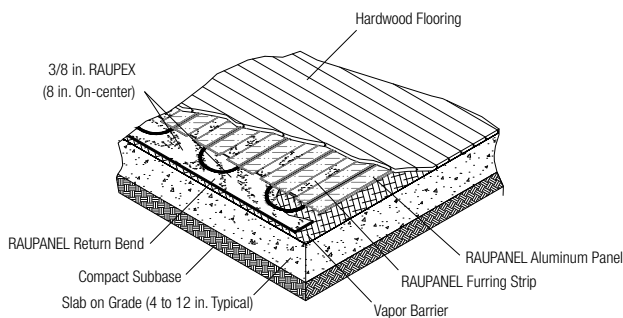

**RAUPANEL 8 in. On-center/Slab on Grade
Hardwood/Engineered Wood Flooring**

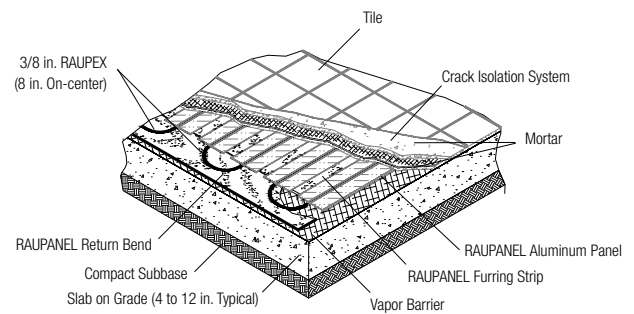

RAUPANEL 8 in. On-center/Slab on Grade Tile Flooring

Fig. 28 Typical finished floor assemblies over RAUPANEL applied to slab.

For updates to this publication, visit www.na.rehau.com/resourcecenter

The information contained herein is believed to be reliable, but no representations, guarantees or warranties of any kind are made as to its accuracy, suitability for particular applications or the results to be obtained therefrom. Before using, the user will determine suitability of the information for user's intended use and shall assume all risk and liability in connection therewith.

©2021 REHAU 855.625 US,CA/en 09.2021