

# NEA SMART 2.0

EN End user manual

This user manual for the “NEA SMART 2.0 control system” is valid from April 2024. This document is protected by copyright. The rights conferred therein are reserved, in particular those relating to the translation, reprinting, extraction of pictures, electronic transmissions, reproduction by photo-mechanical or similar means and storage on data processing equipment. All dimensions and weights are approximate. Subject to errors and modifications.

# Contents

<b>01</b>	<b>Information and safety instructions</b>	<b>03</b>	
<b>02</b>	<b>Introduction</b>	<b>04</b>	
02.01	Application area	04	
02.02	Functions and operation	05	
02.03	System components	07	
<b>03</b>	<b>Operation via the Room unit</b>	<b>10</b>	
03.01	Display information	10	
03.02	Order of the displayed information	13	
03.03	Setting the desired temperature	14	
03.04	Operating procedure (Fan Coils, Operation Mode, Energy Level) <sup>1)</sup>	15	
<b>04</b>	<b>Displays on the Base, R- and U-Module</b>	<b>18</b>	
04.01	NEA SMART 2.0 Base 24 V / 230 V	18	
04.01.01	WIFI / LAN connection to internet (cloud mode) – LED status	19	
04.01.02	Access point (AP) connection – LED status	19	
04.02	NEA SMART 2.0 R-Module 24 V / 230 V	20	
04.03	NEA SMART 2.0 U-Module 24 V	20	
<b>05</b>	<b>Operation via integrated web pages</b>	<b>21</b>	
05.01	General	21	
05.02	Setting up the base for using the web pages	21	
05.02.01	Step 1: Activate Access Point (AP) at master base	21	
05.02.02	Step 2: Establishing a connection between the master base and the PC / tablet / smartphone	22	
<b>06</b>	<b>Usage of the integrated web pages</b>	<b>24</b>	
06.01	Connection	24	
06.02	User Area	24	
06.03	Main menu	24	
06.04	Rooms	25	
06.04.01	Room page	25	
06.04.02	Extended room page	25	
06.05	Timer programs	26	
06.06	System	27	
06.07	Dehumidifier settings	27	
06.08	IT settings	28	
06.08.01	Connection to a router via WIFI	28	
06.08.02	Direct WIFI connection to an external device via access point (AP)	28	
06.09	Fan coils	29	
06.09.01	Basic Settings	29	
06.09.02	Advanced Settings	31	
06.10	KNX	32	
<b>07</b>	<b>Usage of the NEA SMART 2.0 App</b>	<b>33</b>	
07.01	Using the App	33	
07.02	Setting up the base for connecting to the internet and using the App	33	
07.02.01	Establish a LAN connection to the internet	34	
07.02.02	Establish a WIFI connection to the Internet	35	
07.02.03	WPS – Establish a WIFI connection to the Internet via WPS	37	
07.03	Setting up the NEA SMART 2.0 App	38	
07.04	Getting to know the App	40	
07.04.01	Home	40	
07.04.02	Room page	40	
07.04.03	Energy Level for rooms	40	
07.04.04	Operating Mode	41	
07.04.05	Set points for temperature in timed mode	41	
07.04.06	Advanced Menu	41	
07.04.07	Timing programs	42	
07.04.08	Diagnostics	42	
07.04.09	Messages	42	
07.04.10	More	43	
07.04.11	Display weather data for the location of the installation and enter contact data	43	
07.04.12	Smart function Geofencing	44	
07.04.13	Automatic update of the NEA SMART 2.0 App (OTA)	45	
07.04.14	Update the display of the NEA SMART 2.0 App	45	
07.05	Using fan coils	46	
07.05.01	Basic Settings	46	
07.05.02	Advanced Settings	48	
07.05.03	App Pages using Example Configurations	50	
<b>08</b>	<b>Battery (battery-operated thermostat only)</b>	<b>53</b>	
<b>09</b>	<b>Error description</b>	<b>54</b>	
09.01	NEA SMART 2.0 Room unit	54	
09.02	NEA SMART 2.0 Room probe	54	
09.03	Faults and possible causes	54	
<b>10</b>	<b>Technical data NEA SMART 2.0</b>	<b>56</b>	
10.01	NEA SMART 2.0 Room unit	56	
10.02	NEA SMART 2.0 Room probe	57	
10.03	Base	58	
10.03.01	NEA SMART 2.0 Base 24 V	58	
10.03.02	NEA SMART 2.0 Base 230 V	59	
10.04	Extension modules	60	
10.04.01	NEA SMART 2.0 R-Module 24 V	60	
10.04.02	NEA SMART 2.0 R-Module 230 V	60	
10.04.03	NEA SMART 2.0 U-Module 24 V	61	
10.05	Accessories	62	
10.05.01	NEA SMART 2.0 Transformer	62	
10.05.02	NEA SMART 2.0 Outdoor sensor	62	
10.05.03	NEA SMART 2.0 Remote sensor	63	
10.05.04	NEA SMART 2.0 VL / RL sensor	63	
10.05.05	NEA SMART 2.0 Antenna	63	
10.05.06	Thermal actuator UNI 24 V	64	
10.05.07	Thermal actuator UNI 230 V	64	
10.05.08	NEA SMART 2.0 KNX Gateway	65	
10.05.09	NEA SMART 2.0 Power supply gateway	66	
10.05.10	Coupling Relay 24 V / 230 V	67	
10.05.11	Switching Relay 24 V / 230 V	67	
10.05.12	NEA SMART 2.0 Bus Cable (10 / 50 m bundle)	67	

# 01 Information and safety instructions

## Product conformity and safety

### Product conformity

Hereby, REHAU Industries SE & Co. KG declares that the radio equipment type NEA SMART 2.0 Base 230 V and NEA SMART 2.0 Base 24 V is in compliance with EU directive 2014/53/EU and UK regulation UK: 2017 No. 1206.

Frequency: 869 MHz

Transmission power: max. +12 dBm

The full text of the EU and UK declaration of conformity is available at the following internet address: [www.rehau.com/neasmart2](http://www.rehau.com/neasmart2)

### Safety information

#### Intended use

The NEA SMART 2.0 control system may only be planned, installed and operated as described in these instructions and in the other documents belonging to this system. Any other use is not intended and therefore inadmissible.

Observe all national and international installation, accident prevention and safety regulations when installing piping systems and electrical equipment as well as observe the information in this manual. Areas of application that are not covered in these instructions (special applications) require consultation with our application technology department.

Contact your REHAU sales office.



Our systems have to be installed by authorized and trained persons, and work on electrical systems or parts of cables only by trained and authorized persons.

---

### Pictograms and logos

Warnings and general information are marked with the symbols listed below.



Danger to life due to high voltage



Safety information



Legal information



Important information which must be observed



Information on the Internet



Your benefits

### Authorised personnel

The electrical installation must comply with the applicable national regulations and the regulations of the local power supplier.

This manual requires special knowledge corresponding to an officially recognised qualification in one of the following professions:

- Electrical or electronics engineer

In accordance with the international regulations as well as the comparable professions within your specific national legal framework.

### Cleaning

Only use a dry, solvent-free, soft cloth for cleaning.

### Disposal

The batteries and all components of the NEA SMART 2.0 system must not be disposed with domestic waste. The user has the duty to dispose of the devices at designated collection points. The separate collection and orderly disposal of all materials will help to conserve natural resources and ensure recycling in a manner that protects human health and the environment. If you need information about collection points for your devices, please contact your local council or your local waste disposal services.

### Parameter setting – Expert

The control unit is equipped with different parameters. These parameters can be easily changed for your specific application.

---



Please note that the parameter areas may only be operated by an installer or a qualified person. Changing the parameters can have serious consequences for the heating and / or cooling systems.

---



Please enter all parameter changes in the "installer's notes" section.

## 02 Introduction

Congratulations on the purchase of the REHAU NEA SMART 2.0 control system. We are pleased that you have chosen a control system from REHAU. We hope that you enjoy your product.

### 02.01 Application area

NEA SMART 2.0 is a modern and effective control system with a wide range of functions for

- radiant heating / cooling systems such as floor, wall, ceiling
- thermally activated building systems (TABS) such as concrete core temperature (CCT), concrete core temperature close to the surface (sCCT), industrial floor heating / cooling (IFHC)
- dehumidifier units
- switched fan coils and modulated RAUCLIMATE SILENT BREEZE fan coils

Important features include:

- clear and high-quality design of room units
- fully automated control of the entire system
- integrated WIFI / LAN interface for operation using a web browser or an App as standard

- smart functions, which ensure a high level of comfort and ensure effective operation
- suitable for new installations and retrofitting



The functions and operations described in this manual are based on the following software versions:

#### Base

From software version V6.0.

Display of the software version on the webpages under "System" or in the mobile app under "Settings > General". If your system has an older software version, please perform an over-the-air update.

#### Room units

From software version V1.7 and with humidity measurement of type HBW, HRW, HBB, HRB.

No over-the-air update is possible for room control units.

#### 1 NEA SMART 2.0 Base

- Central control unit for 8 rooms
- Hybrid technology: suitable for bus and wireless room units / room probes
- WIFI / LAN featured as standard



#### 2 UNI thermal actuators

- Normally closed



#### 3 NEA SMART 2.0 Room units / Room probes

- High-quality design
- LED matrix display (only with room units)
- Bus and wireless variants



#### 4 Systems

- Floor
- Wall
- Ceiling
- CCT
- sCCT
- IFHC
- Dehumidifiers
- Switched fan coils
- Modulated RAUCLIMATE SILENT BREEZE fan coils

#### 5 App

- Configuration via smartphone / tablet
- Operation worldwide
- Remote maintenance and monitoring

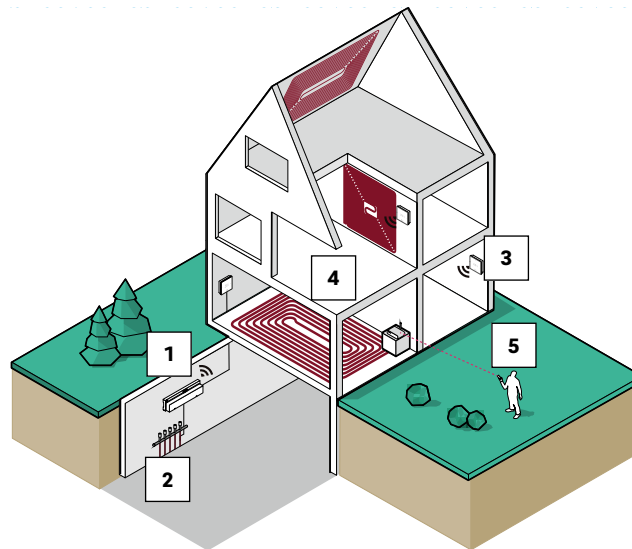
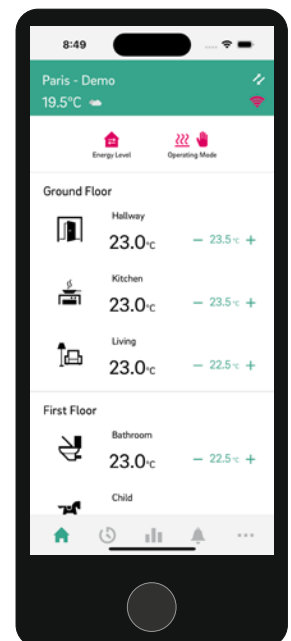

Fig. 02-1 NEA SMART 2.0 control system

## 02.02 Functions and operation

### What can the NEA SMART 2.0 system do?

The basic function of the system is to heat the rooms conveniently and economically according to your wishes.

Depending on the installed system, however, many other functions are available:

- Room cooling via combined heating / cooling areas
- Automatic or manual switching between heating, neutral and cooling
- Controlling the optimum temperature for the supply of the heating / cooling areas ("flow temperature control")
- Dehumidification of rooms

Using the room units or via the App, the target temperatures for heating and cooling respectively can be set in the energy levels eco (REDUCED / Absent Mode) and comfort (NORMAL / Present Mode).

### How can I operate the system?

You can operate the system

- directly via the room unit
  - setting the desired temperatures
  - changing the operation mode: heating, cooling
  - setting the energy levels: REDUCED, NORMAL, STANDBY, AUTOMATIC with Timer, PARTY
  - operating fan coils

- via the browser of your smartphone, tablet or PC (integrated web pages can only be used inside your home)
- via the cloud using the NEA SMART 2.0 App

The NEA SMART 2.0 App is easy and convenient to use, and offers many features that make the system a truly smart system.

### What can be set or viewed?

Depending on the options installed in the system, there is a wide range of possibilities for setting room temperatures on-site or on the go, adapting the system to your needs, viewing statistics or receiving information.

The table 02-1 (next page) provides you with an overview of the different options.

Please note that for operation via the App (cloud connection), it does not matter where you are, whilst operation via the integrated web pages only works within your home.

What can I do?	Via room unit	Web pages (local)	App (via cloud)
Read room temperature, read and set the desired temperature	✓	✓	✓
Select the energy level "timer programme", "normal" or "reduced"	✓	✓	✓
Set timer programmes and assign them to rooms		✓	✓
Assign room names		✓	✓
Set desired temperatures for the rooms according to the timer programme		✓	✓
Select operation mode „heating“, „cooling“ or „automatic switching between heating and cooling“	✓	✓	✓
Use holiday function		✓	✓
Automatic reduction of energy consumption during absence (geofencing)			✓
View temperature profiles of rooms			✓
For dehumidifier control: Change the switch-on values		✓	✓
For fan coil control – selection of <ul style="list-style-type: none"> <li>▪ operating state ON, OFF</li> <li>▪ speed stage STANDBY, MIN, MED, MAX<sup>1)</sup></li> <li>▪ fan flap (on / off) to switch between oscillating and directional airflow<sup>1)</sup></li> </ul>	✓	✓	✓
For fan coil control – selection of <ul style="list-style-type: none"> <li>▪ tolerance level (ECO, COMFORT, NORMAL)</li> <li>▪ lock to deactivate</li> <li>▪ activation / deactivation in REDUCED mode</li> <li>▪ maximum possible air speed (MIN, MED, MAX)<sup>1)</sup></li> <li>▪ presetting of the fan speed stage (STANDBY, MIN, MED, MAX) in energy level NORMAL and REDUCED<sup>1)</sup></li> <li>▪ Activation of "Comfort Cooling PLUS" function to increase comfort in uncomfortably high humidity conditions<sup>1)</sup></li> </ul>		✓	✓
View status, error and warning information	✓ <sup>2)</sup>		✓
Automatically reduce energy consumption during absence			✓
Remote maintenance (only for installer)			✓
Receive information on system optimisation			✓

Tab. 02-1 NEA SMART 2.0 possible settings

<sup>1)</sup> For RAUCLIMATE SILENT BREEZE fan coils

<sup>2)</sup> Concerning the room in which the room unit is installed

## 02.03 System components

### Room unit

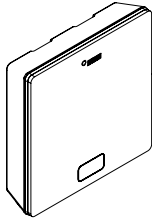

The room unit serves as a room temperature and humidity sensor as well as an operating unit for the room temperature setpoints, operation modes (heating, cooling), energy levels (REDUCED, NORMAL, STANDBY, AUTOMATIC, PARTY) and fan coils. The room unit is equipped with a LED matrix display and is mounted on the wall in every room. The room unit is operated via a central button and capacitive plus / minus buttons.

Variants:

- Bus or wireless technology
- With temperature or temperature / humidity sensor
- Housing colour: black or white

### Room probe

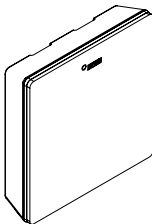

The room probe serves as a room temperature and humidity sensor. It can be mounted on the wall in any room, particularly in rooms where direct temperature adjustment is not required. Using room probes the system has to be operated via App or web pages.

Variants:

- Bus or wireless technology
- With temperature or temperature / humidity sensor
- Housing colour: white

### Base 24 V / 230 V

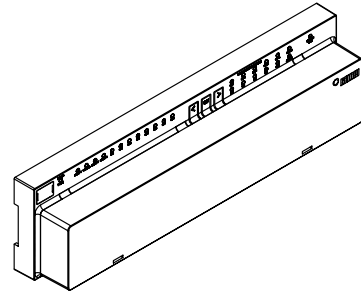

The base is a central control unit for underfloor heating and cooling systems and is normally located in the heating circuit manifold box. Up to 8 room units or room probes can be connected to the base via bus or wireless technology.

### Transformer

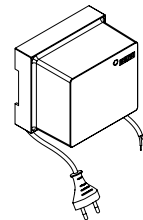

The transformer powers the base 24 V and is normally positioned in the heating circuit manifold box.

### R-Module 24 V / 230 V

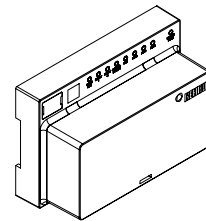

The R-Module is used to extend the base by 4 rooms. It is usually located in the heating circuit manifold box.

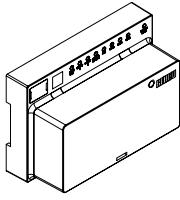
**U-Module 24 V**

The U-Module 24 V is a universal extension module for the base. Depending on the configuration, it can be used to control the flow temperature, actuate up to 2 dehumidifiers or switched fan coils as required.

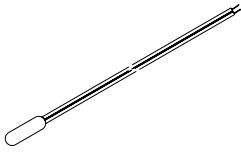
**Remote sensor**

Temperature sensor for connection to:

- U-Module for measuring outdoor temperature
- Room unit / Room probe for monitoring floor temperature, room temperature and measuring core temperature in TABS applications

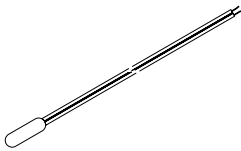
**VL / RL sensor**

Temperature sensor for connection to:

- U-Module for measuring flow (supply) and return temperature in a mixed heating circuit
- Room unit / Room probe for measuring return temperature in TABS application

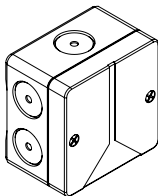
**Outdoor sensor**

The wireless outdoor sensor measures the external temperature and is located on an outer wall of the building. The outdoor sensor is assigned to a NEA SMART 2.0 Base.

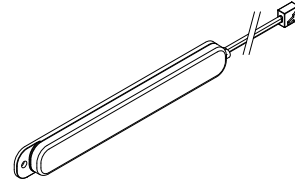
**Antenna**

The antenna serves as an option to increase the range of the wireless signal to the wireless room units or room probes. The antenna is connected to the base and is installed outside the heating circuit manifold box.

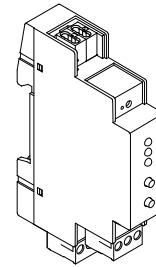
**KNX Gateway**

The KNX gateway module enables data transmission from the NEA SMART 2.0 control technology to a KNX system. Values such as: setpoints, actual values, operating modes and energy levels can be exchanged with a higher-level KNX system such as a BMS.

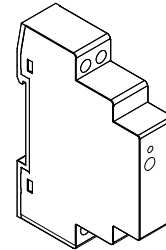
**Power supply gateway**

The power supply gateway module is used to generate the auxiliary voltage for the NEA SMART 2.0 KNX gateway module.

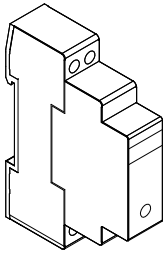

**Coupling Relais 24 V / 230 V**

The coupling relay is used to transfer 24 V AC or 230 V AC switching signals of a heat or cold generator or a superordinate building management system to the digital inputs of the NEA SMART 2.0 control system.

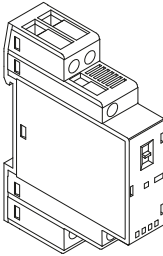
**Switching Relais 24 V / 230 V**

The switching relay is used to connect to triac outputs or relay outputs of the NEA SMART 2.0 24 V / 230 V control system and to control external devices, additional actuators or to forward signals to other building technology units.

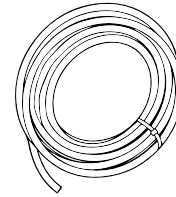
**NEA SMART 2.0 Bus cable (10 / 50 m bundle)**

The NEA SMART 2.0 Bus cable can be used to wire the system bus (SYSBUS) and zone bus (ZOBUS) of the NEA SMART 2.0 control system.

## 03 Operation via the Room unit

### 03.01 Display information



Fig. 03-1 NEA SMART 2.0 Room unit

The Room unit is operated using the Home Button and the +/- symbols.



The display is switched off when in sleep mode. It is activated by pressing the Home button. Only then the plus/minus symbols become visible. Flashing symbols or numbers can be modified.

The room units (room controller with LED matrix display from SW version 1.7) allow the user:

- Switching the operating mode of the NEA SMART 2.0 system between heating, cooling or automatic switching between heating and cooling on enabled room units
- Basic settings for the operation of fan coils such as selection of the fan coil operating status ON, OFF and the fan speed stages STANDBY, MIN, MED, MAX as well as the activation / deactivation of the fan coil flap (on / off) to switch between oscillating and directional airflow

#### MINUS SYMBOL

- Reduce the desired temperature
- Previous menu item

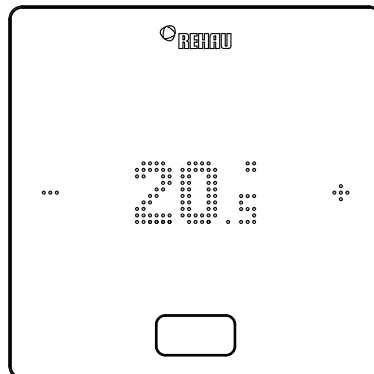

#### PLUS SYMBOL

- Increase the desired temperature
- Next menu item

#### HOME Button

- Activate display
- Next menu item
- Confirm

### Display of temperature



Shows the current room temperature or the desired room temperature.

### Display of room humidity<sup>1)</sup>

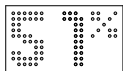

Shows the relative humidity in the room.

### Display of the operating mode

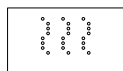

**Heating mode – automatic start**



**Heating mode – manual**

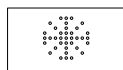

**Cooling mode – automatic start**



**Cooling mode – manual**

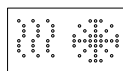

**Heating / cooling mode – automatic switching**

### Status indicator of operating mode

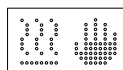

The status "Heating active" and "Cooling active" is indicated by an underscore below the heating icon (wave) or cooling icon (ice crystal).

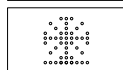

### Operating status / Energy levels

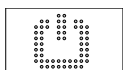

**Standby mode**



When Standby mode is selected, automatic frost protection is active. As soon as the temperature drops below a limit temperature, which can be individually set, the heating valve is activated. The default of the limit temperature is 5 °C.

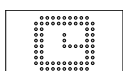

**Automatic mode**

The selected timer programme for the room is active.



When the symbol for automatic mode is displayed, the set energy level is displayed afterwards (Normal or Reduced).

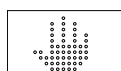

**Manual**

User has changed the desired temperature; valid until the next switching point.

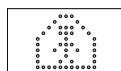

**Normal mode (Present mode)**

Operating mode Normal is active  
Standard desired temperature 22 °C

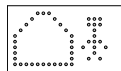

**Reduced mode (Absent mode)**

Operating mode Reduced is active  
(energy-saving mode)  
Standard desired temperature 18 °C

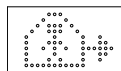

**Transitional phase Normal**

Transitional phase Normal to Reduced operating mode

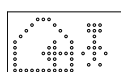

**Transitional phase Reduced**

Transitional phase Reduced to Normal operating mode

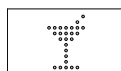

**Party mode**

Party mode is active



The party mode allows the user to switch from the reduced operating mode to the normal operating mode for a period of time. The thermostat automatically returns to the reduced operating mode when the party time has elapsed.

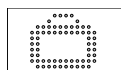

**Holiday mode**

Holiday mode is active



- Holiday mode / Vacation mode can only be activated with the App or on the web page.
- The vacation symbol only appears on the display when holiday mode / vacation mode is active.

<sup>1)</sup> Only for room units with humidity measurement.

**Display of fan coil speed stages<sup>1)</sup>**

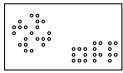

**Fan coil is manually stopped (OFF) or permanently deactivated**



**Fan coil is manually started (ON)**  
Fan coil is only active (fan running) when the conditions (setpoints, actual values, settings) allow it

When using RAUCLIMATE SILENT BREEZE fan coils:



**STANDBY**

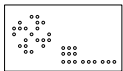

**MIN – lowest speed stage**



**MED – medium speed stage**

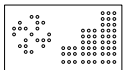

**MAX – highest speed stage**

**Display of fan coil flap mode<sup>1)</sup>**

When using RAUCLIMATE SILENT BREEZE fan coils with flap:



**Flap OFF: airflow is directional**

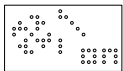

**Flap ON: airflow is oscillating**

**Status indicator fan coil in operation<sup>1)</sup>**



Fan coil in operation is indicated by an underscore below the fan icon

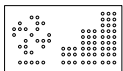

**Room unit locked**

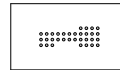

Buttons are locked

**Error message**

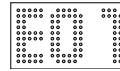

Displays an error number – see chapter 09

**Warning message**

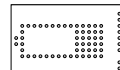

**Low battery**

The battery of the Room unit must be replaced.

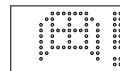

**Window open**

An open window has been detected in this room.

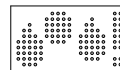

**Condensation**

High humidity – risk of condensation

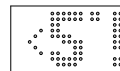

**Frost protection active**

Frost protection has been activated as the temperature has fallen below 5 °C; the heating valve is activated.



**Filter cleaning indicator**

The filter cleaning indicator notifies the user to clean the filter when using RAUCLIMATE SILENT BREEZE fan coils. After cleaning the filter, press the HOME Button for 5 seconds to reset the message.

**Connection status**

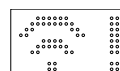

**No connection**

There is no connection to the Base.

<sup>1)</sup> Is displayed if switched fan coils and / or modulating RAUCLIMATE SILENT BREEZE fan coils are installed.

**03.02 Order of the displayed information**

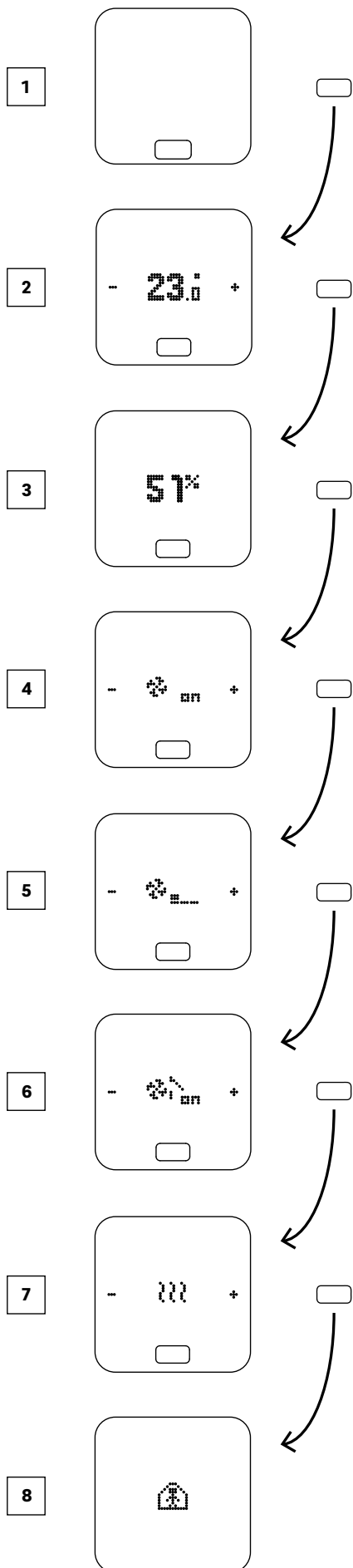

- 1 Initial state
- 2 Display of current room temperature
- 3 Display of current humidity in the room
- 4 Display of fan coil operation mode<sup>1)</sup>
- 5 Display of fan coil speed stage<sup>2)</sup>
- 6 Display of fan coil flap mode<sup>3)</sup>
- 7 Display of Operation Mode  
Options: Heating, Cooling
- 7 Display of Energy Levels  
Options: Normal, Reduced, Standby, Automatic with Timer, Party

<sup>1)</sup> Displayed if switched fan coils and / or modulating RAUCLIMATE SILENT BREEZE fan coils are configured  
<sup>2)</sup> Displayed if modulating RAUCLIMATE SILENT BREEZE fan coils are configured  
<sup>3)</sup> Displayed if modulating RAUCLIMATE SILENT BREEZE fan coils with flap are configured

**03.03 Setting the desired temperature**

To activate the display, press the Home button once.  
 To see the target value, press +/- once

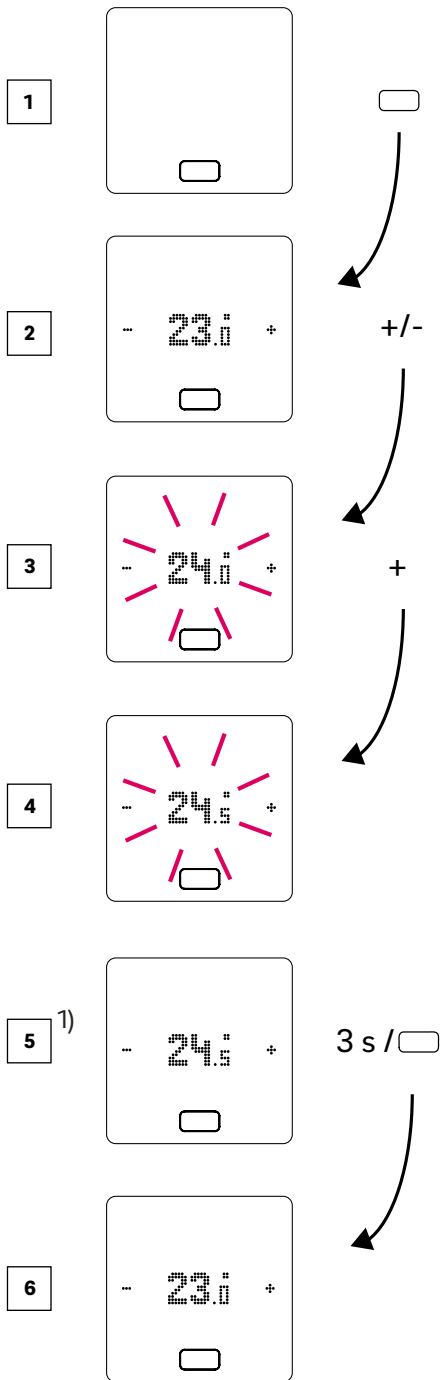

- 1 Initial state
- 2 Display of current room temperature
- 3 Display of the setpoint of the room temperature
- 4 Display of the setpoint of the room temperature during operation
- 5 Display of the final setpoint for the room temperature
- 6 Display of current room temperature

<sup>1)</sup>Optional: If the Room unit has a light ring, it flashes additionally for confirmation

### 03.04 Operating procedure (Fan Coils, Operation Mode, Energy Level)<sup>1)</sup>

#### 1 Initial state

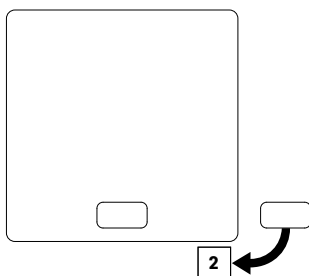

#### 2 Display of current room temperature and setpoint

- To display the setpoint (desired temperature), press + or – once. Each additional keystroke to + or – increases or decreases the setpoint

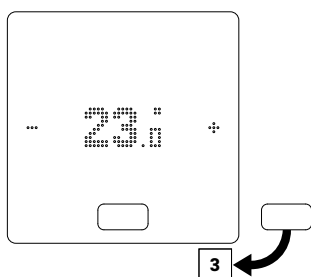

#### 3 Display of current humidity for room units with humidity measurement

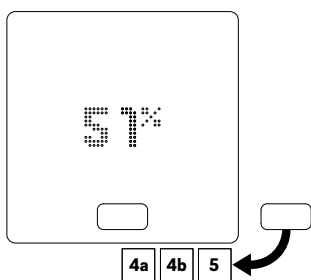

Depending on the configuration, different display options appear after pressing the HOME button:

- 4a Room with switched fan coil
- 4b Room with modulating RAUCLIMATE SILENT BREEZE fan coils also in combination with one switched fan coil
- 5 Room without fan coil

#### 4a Room with switched fan coil

- By pressing + or – the switched fan coil is manually started (ON) or stopped (OFF)

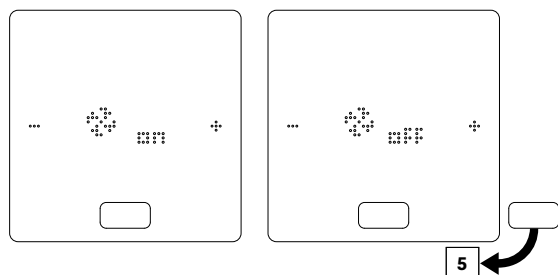

<sup>1)</sup>Note:

- The available selection options depend on the system configuration, the conditions (room temperature setpoints, actual values, ...) and the system settings.
- The current setting is always displayed first

**4b Room with modulating RAUCLIMATE SILENT BREEZE fan coils also in combination with one switched fan coil**

- Switched fan coils and RAUCLIMATE SILENT BREEZE fan coils are permanently deactivated when the setting is OFF
- Switching is made by pressing + or -

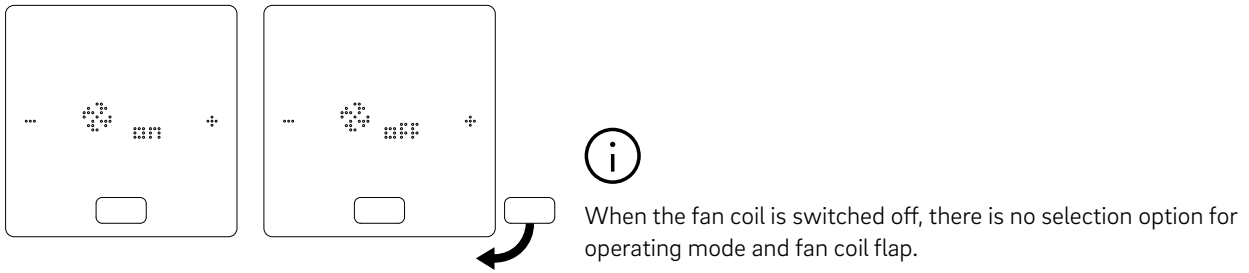

- Changing the fan coil operating mode is done by pressing + or -

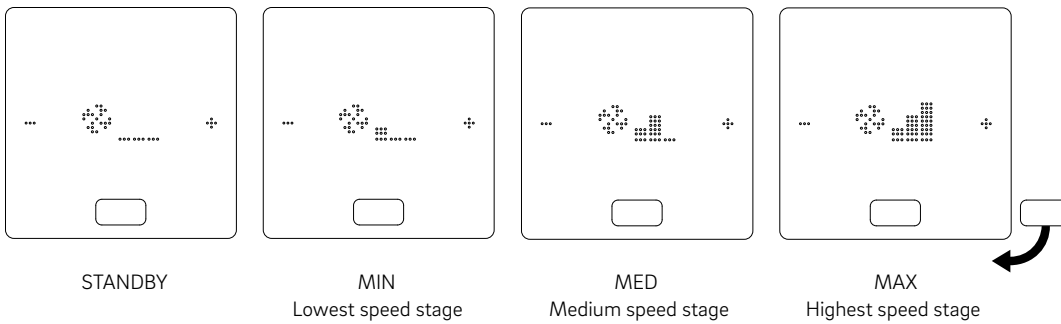

Switched fan coils and RAUCLIMATE SILENT BREEZE fan coils are with the setting

- OFF – permanently disabled
- STANDBY deactivated until the next switching point of a time program arrives or the energy level is manually changed. In this case the default setting for energy level REDUCED / NORMAL is applied.

RAUCLIMATE SILENT BREEZE fan coils are in the setting

- MIN / MED / MAX operated in the selected mode until the next switching point of a time program arrives or the energy level is manually changed. In this case the default setting for energy level REDUCED / NORMAL is applied.

Without the use of timers, the fan coil remains in the selected energy level

- When RAUCLIMATE SILENT BREEZE fan coils with flap are used, the flap can be switched between oscillating (ON) and directional (OFF) airflow by pressing + or -

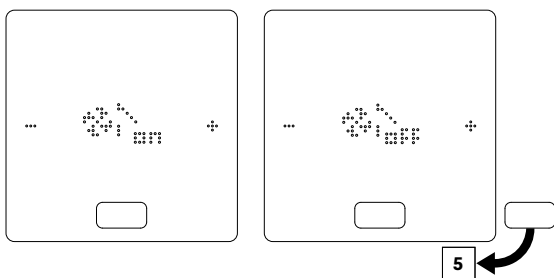



**5 Display and switching of the Operation Mode**

- Switching of operation mode is only available on room units which have been activated for this purpose in the installer area.
- Only if switching of operation mode is enabled, the +/- signs appear to allow switching.
- The configuration of the system and the actual conditions determine the modes of operation which may be selected by the user.

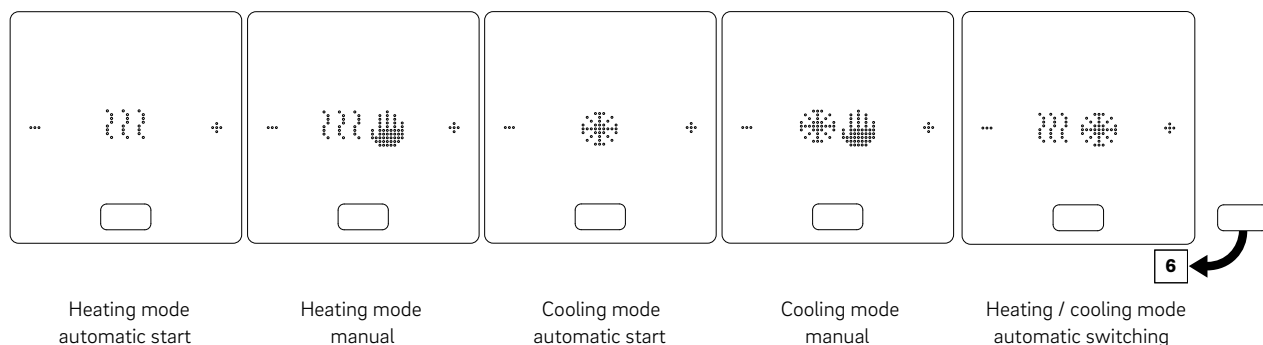

**6 Display and switching of Energy Levels**

- The energy level can be changed by pressing +/-
- The current operating status is always displayed first.

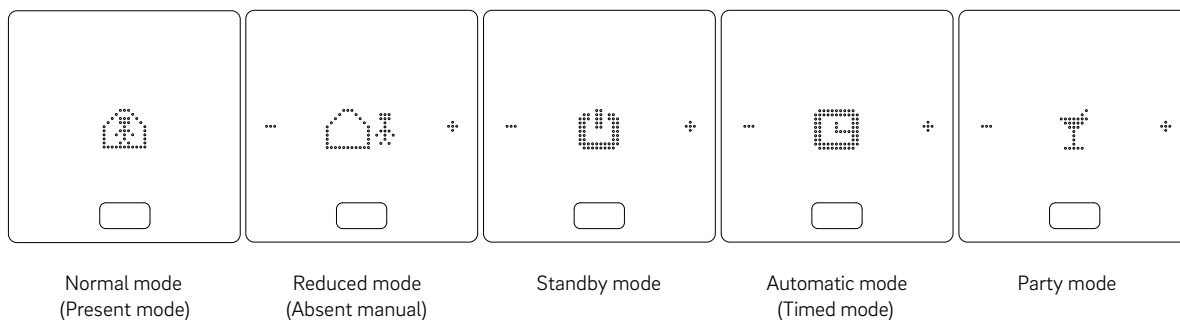

**Status indicator of Operation Mode**

- The status "Heating active" and "Cooling active" is indicated by an underscore below the heating icon (wave) or cooling icon (ice crystal).

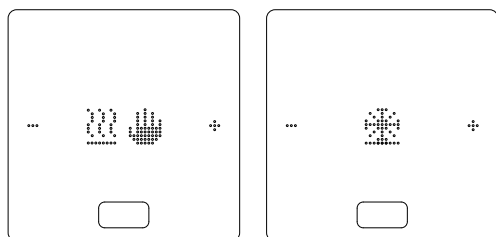

**Status indicator Fan Coil**

- The status indicator "Fan Coil in operation" is indicated by an underscore below the fan icon.

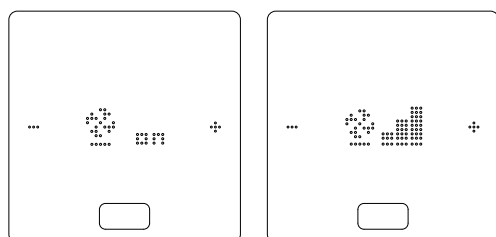

## 04 Displays on the Base, R- and U-Module

### 04.01 NEA SMART 2.0 Base 24 V / 230 V

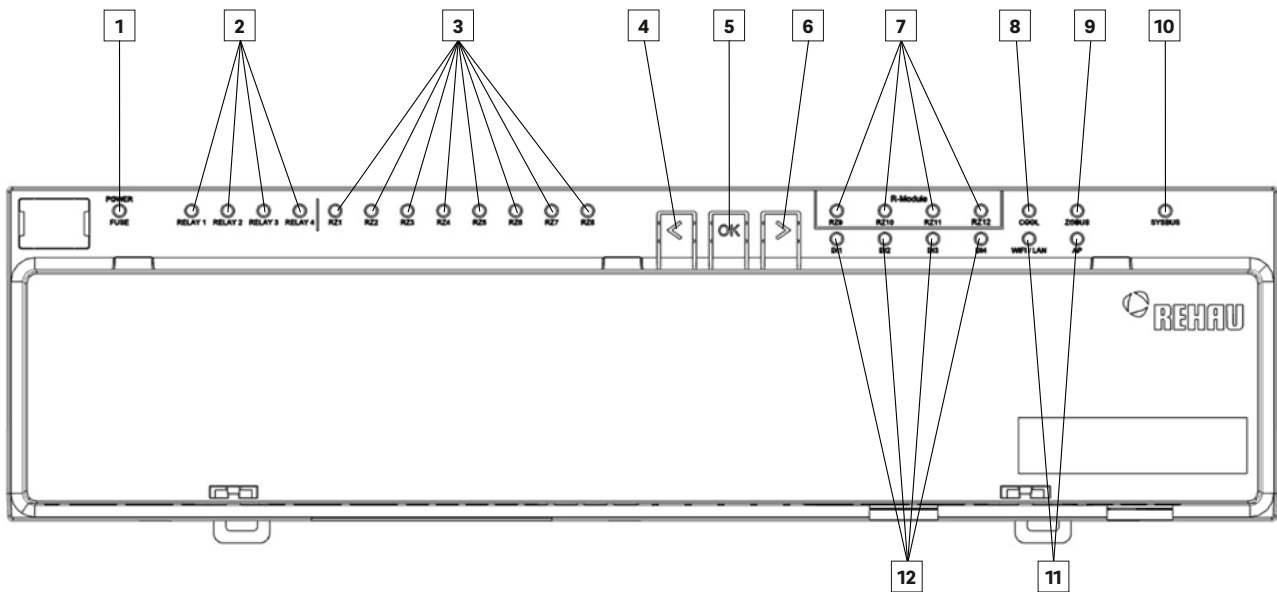



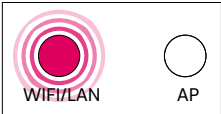





Fig. 04-1 NEA SMART 2.0 Base 24 V / 230 V – labelling LED display

<p><b>1 POWER / FUSE</b> Green: Power supply OK Red: Power supply is connected and fuse is defective Off: No power supply connected</p>	<p><b>7 RZ9 ... RZ12</b> LED status display of the room zones (RZ) 9 ... 12 of the R-Module Green: active</p>
<p><b>2 RELAY 1 ... RELAY 4</b> LED status display of the configurable relay outputs (potential-free contacts) Green: active</p>	<p><b>8 COOL</b> LED status display of the cooling mode Blue: cooling mode active</p>
<p><b>3 RZ1 ... RZ8</b> LED status display of the room zones (RZ) 1 ... 8 Green: active</p>	<p><b>9 ZOBUS</b> Green: shows communication between base, room units, room probes and R-Module.</p>
<p><b>4 Left button</b></p>	<p><b>10 SYSBUS</b> Green: shows communication between bases, U-Modules, RAUCLIMATE SILENT BREEZE fan coils and KNX-Gateways.</p>
<p><b>5 Confirmation button</b></p>	<p><b>11 WIFI / LAN, AP</b> WIFI / LAN and Access Point AP status display (see also quickinstall for NEA SMART 2.0 Base)</p>
<p><b>6 Right button</b></p>	<p><b>12 DI1 ... DI4</b> LED status display of the configurable digital inputs 1 ... 4 (window contact, dew point monitor ...) Green: active</p>

**04.01.01 WIFI / LAN connection to internet (cloud mode) – LED status**





4 variants of LED flashing are possible, indicating the connection status between the base and the router or server.

LED status	Connection status	Comment	LED blink code <sup>1)</sup>
<b>A</b> 	Base is communicating with the server	Normal case	ON OFF 
<b>B</b> 	Base is not connected to the router	That's the case when: <ul style="list-style-type: none"> <li>▪ WIFI SSID not valid</li> <li>▪ WIFI password not valid</li> <li>▪ distance of WIFI too long between base and router</li> <li>▪ LAN connection is interrupted</li> <li>▪ Router not ON</li> </ul>	ON OFF 
<b>C</b> 	Base is connected to router and the base can't reach the server	That's the case when: <ul style="list-style-type: none"> <li>▪ (&lt; 1 min) the connection to the server is established</li> <li>▪ (&gt; 1 min) internet of the provider is not available</li> <li>▪ (&gt; 1 min) base is not registered at the server</li> </ul>	ON OFF 
<b>D</b> 	Base is connected to router and the base can reach server but the certificate at the base is not valid	Please contact our support for assistance	ON OFF 

<sup>1)</sup> From software version 2.0

**04.01.02 Access point (AP) connection – LED status**

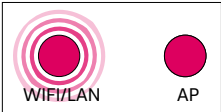
2 variants of LED flashing are possible, indicating the connection status between the base and an external device.

LED status	Connection status	Comment	LED blink code
<b>A</b> 	Base is connected to an external device via access point (AP)	Normal case	WIFI / LAN LED AP LED ON OFF 
<b>B</b> 	No external device is connected to the base via access point (AP)	Connect an external device – see chapter 05.02.02	WIFI / LAN LED AP LED ON OFF  ON OFF 

**04.02 NEA SMART 2.0 R-Module 24 V / 230 V**

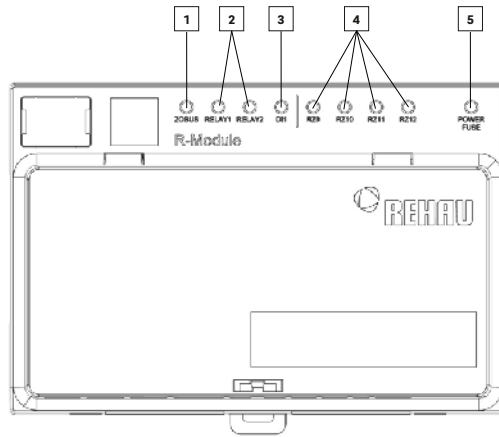

Fig. 04-2 NEA SMART R-Module 24 V / 230 V – labelling LED display

<p><b>1 ZOBUS</b> Green: shows communication with base</p>	<p><b>4 RZ9 ... RZ12</b> LED status display of the room zones (RZ) 9 ... 12 Green: active</p>
<p><b>2 RELAY 1, RELAY 2</b> LED status display of the configurable relay outputs (potential-free contacts) Green: active</p>	<p><b>5 POWER / FUSE</b> Green: Power supply OK Red: Power supply is connected and fuse is defective or no power supply connected</p>
<p><b>3 DI1</b> LED status display of the configurable digital input (window contact, dew point monitor ...) Green: active</p>	

**04.03 NEA SMART 2.0 U-Module 24 V**

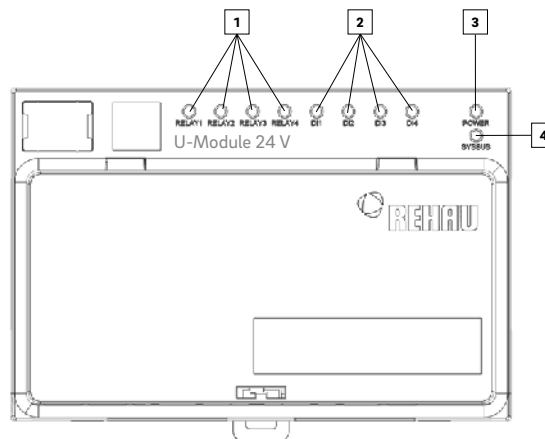

Fig. 04-3 NEA SMART 2.0 U-Module 24 V – labelling LED display

<p><b>1 RELAY 1 ... RELAY 4</b> LED status display of the configurable relay outputs (potential-free contacts) Green: active</p>	<p><b>3 POWER</b> Green: Power supply OK</p>
<p><b>2 DI1 ... DI4</b> LED status display of the configurable digital inputs 1 ... 4 (window contact, dew point monitor ...) Green: active</p>	<p><b>4 SYSBUS</b> Green: shows communication with master</p>

## 05 Operation via integrated web pages

### 05.01 General

The integrated web pages can be used as an alternative to the NEA SMART 2.0 App via the browser of a smartphone, tablet or PC.

The IP address of the device is **192.168.0.2**.

Via the web pages, you can:

- Assign names to the rooms and set the desired temperatures
- Create timer programmes for the desired temperatures and assign them to the rooms
- Select the operating modes "normal mode" and "reduced mode" for all rooms or individual rooms
- Use the holiday function
- Switch between operating mode heating and cooling
- Operate fan coils



To use the web pages, a direct connection must be established between the device (smartphone, tablet, PC) and the NEA SMART 2.0 Base by activating an Access Point (AP) at the base. The web pages can only be accessed with one device at a time.

It is not possible to use the App and the integrated web pages at the same time.

### 05.02 Setting up the base for using the web pages



For systems in which there is more than one base, communication always takes place via the "master" base. Ask your installer which base has been established as the master.

When the system is delivered, the communication functions of the base station via WIFI / LAN and Access Point (AP) are switched off.



The NEA SMART 2.0 Base may only be handled if the cover is in place on the NEA SMART 2.0 Base. If this is not the case, the installer has to be called.

#### 05.02.01 Step 1: Activate Access Point (AP) at master base

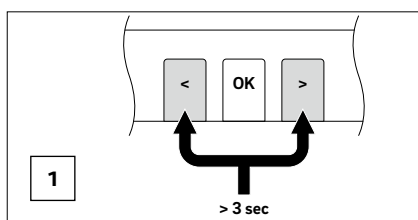

1 Press both arrow buttons < > at the same time for > 3 seconds

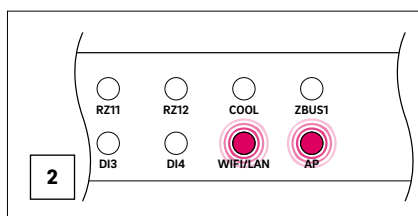

2 The WIFI / LAN LED and / or the AP LED will begin to flash.

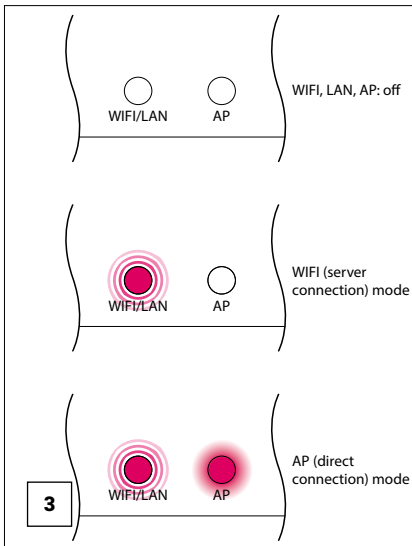

3 Confirm by briefly pressing the OK button. The current status of the transmitting function is displayed.

- WIFI, LAN, AP: OFF
- WIFI (server connection) mode
- AP (direct connection) mode

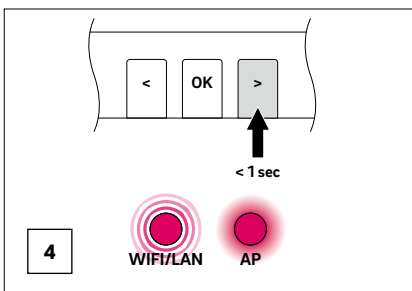

4 By briefly pressing the < or > button, it is possible to switch between the transmitting functions.

Press the < or > button repeatedly until  
→ Access Point (AP) mode is preselected.

In this case, the WIFI / LAN LED flashes fast and the AP LED lights up permanently.

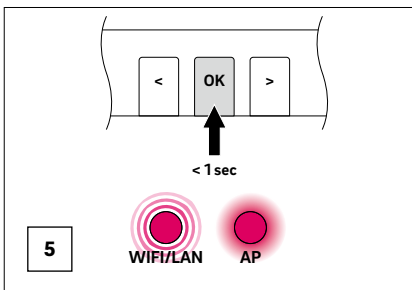

5 Confirm by briefly pressing the OK button.

In this case, the WIFI / LAN LED flashes slowly and the AP LED lights up permanently.

- Access Point (AP) mode is activated
- No device is connected with master base up to now

The NEA SMART 2.0 Base is now ready for direct connection to a PC or a tablet / smartphone.



If no buttons are pressed for a certain time, the NEA SMART 2.0 Base will return to the initial state. In this case, the sequence for activating the transmitting function can be started again.



With the transmitting function activated, the wireless LAN (WIFI) network transmitted by the NEA SMART 2.0 Base is visible to every user – similar to the wireless LAN network of a router. It is recommended to change the default password during the initial set-up. If the password has been forgotten, it can be reset to the delivery status. See chapter 06.08.02 for details.

## 05.02.02 Step 2: Establishing a connection between the master base and the PC / tablet / smartphone

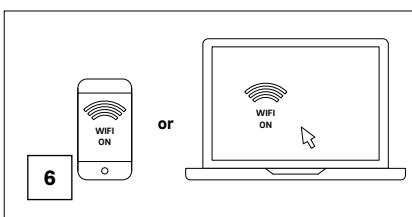

6 On the PC / tablet / smartphone

- switch on WIFI
- open the WIFI menu and view the available networks

**Note:** The distance between the PC / tablet / smartphone should not exceed approx. 5 m.

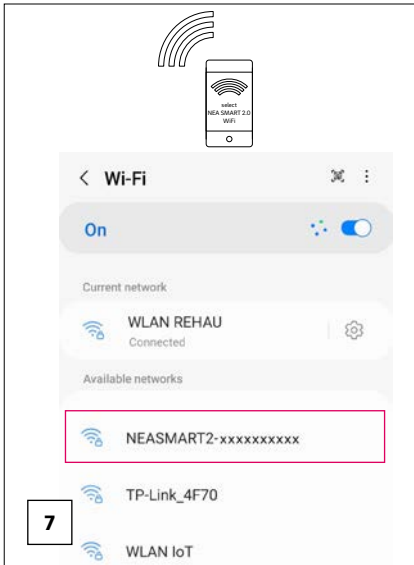

- 7 Select the wireless LAN network with the name "REHAU-xxxxxxxxxx".  
xxxxxxxxxx = individual number of master base.

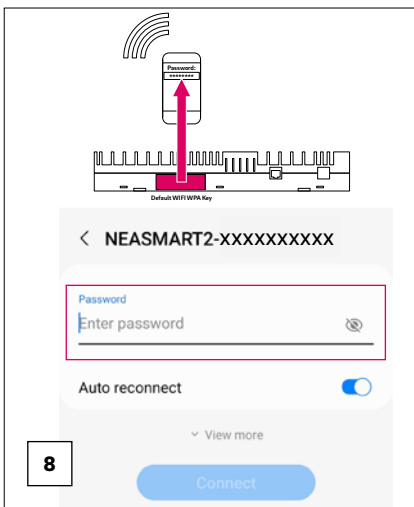

- 8 After selecting the REHAU network, the security key needs to be entered. The security key (default Wi-Fi WPA2 key) can be found on the label of the base station. After a few seconds, the PC / tablet / smartphone connects to the base station.

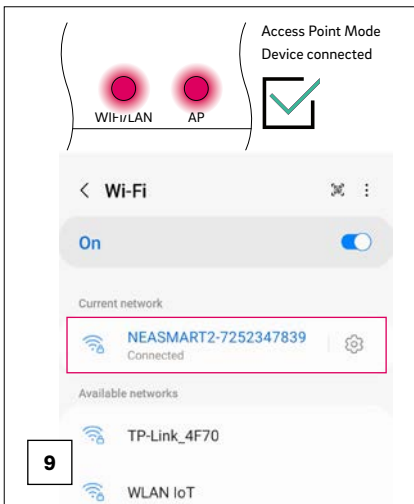

- 9 The successful connection is displayed on the base station. Both the WIFI / LAN LED and the AP LED are permanently lit.

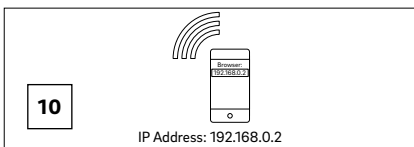

- 10 Open the Internet browser on a PC / tablet / smartphone (e.g. Chrome, Firefox, Edge, ...) and enter the IP address <http://192.168.0.2> in the address bar. The home page of the integrated web pages opens.

# 06 Usage of the integrated web pages

## 06.01 Connection

The procedure how to connect a smartphone, tablet or laptop with the NEA SMART 2.0 Base is described in chapter 05 of this manual.

## 06.02 User Area

Depending on the type of system, the integrated web pages offer the following options:

- Selection of the operating modes of the overall system: heating, cooling
- Selection of energy levels: Standby, Normal, Reduced via time program or continuously
- Managing timer programs
- Specification and management of room temperature
- Using the party or holiday function
- Operating fan coils
- Specification of the mode of operation of dehumidifiers
- Connecting the system to the Internet to use the App
- Additional setting options



Always press the CONFIRM button to apply changes.

## 06.03 Main menu

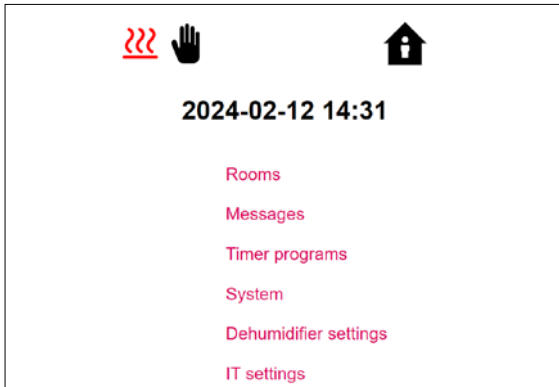

Fig. 06-1 Web page: Main menu

In the main menu, you can see the current operating mode – shown here: “Heating manual” and “NORMAL” (Present – person in the house).

By clicking the symbols, the different operating modes and energy levels can be selected (depending on the present conditions).

Operating modes:

- Heating manual
- Cooling manual
- Heating only, automatic start
- Cooling only, automatic start
- Automatic switch between heating and cooling

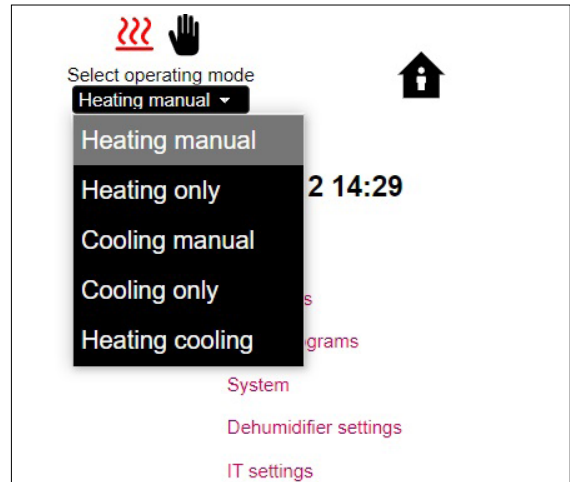

Fig. 06-2 Web page: Operating mode

Energy levels:

- Permanent “NORMAL” (Present) or “REDUCED” (Absent)
- Operation via time program
- System switched off (standby)
- Holiday

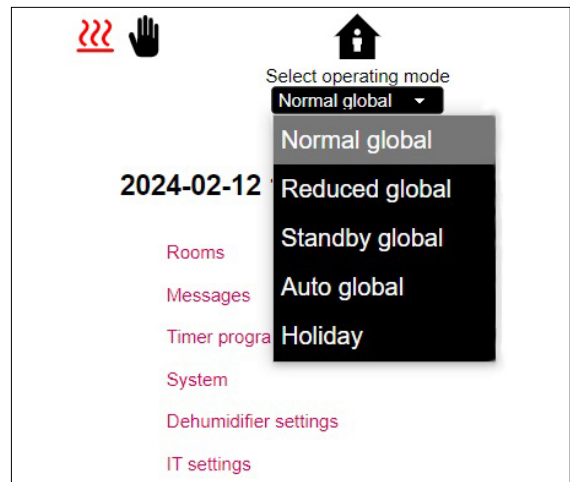

Fig. 06-3 Web page: Energy level



In order to ensure comfortable conditions and energy-efficient operation, we recommend selecting the timed operating mode.

Click the menu items to access the respective submenus (Rooms, ...).



**06.04 Rooms**

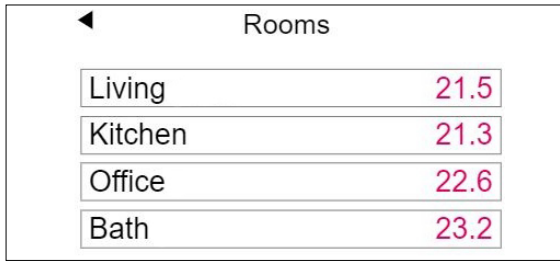

Fig. 06-4 Web page: Room selection

Here, you can see the individual rooms with their current room temperatures. Clicking a room takes you to the individual room page.

**06.04.01 Room page**

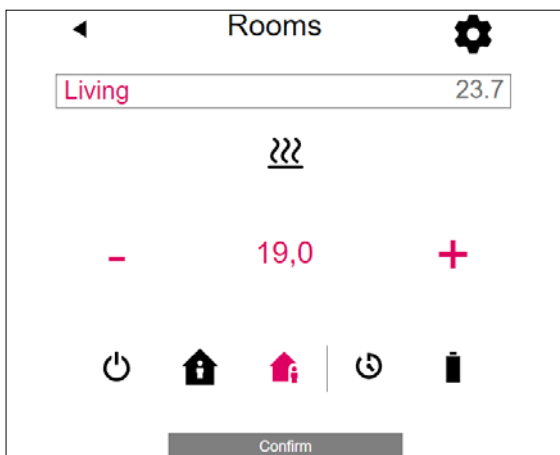

Fig. 06-5 Web page: Room page settings

Here, the target (setpoint) temperature, the actual temperature, the operating mode, the energy level and in case of wireless room units the battery status are displayed.

In this example:

- Actual temperature: 23,7 °C
- Target temperature: 19,0 °C
- Operating mode: heating
- Energy level: reduced (absent)
- No time programme active
- Battery status of the wireless room unit

The target temperature value can be changed by using the plus and minus symbols.

Energy levels (STANDBY, NORMAL, REDUCED, TIMED) can be changed by pressing the symbol.

**Note:**

- Changes to the room temperature target value during timed operating mode are valid until the next switching point of the time program
- Changes during fixed "normal" or "reduced" mode are set as new standard values for this mode.

By clicking the gear symbol, you can access the extended settings.

**06.04.02 Extended room page**

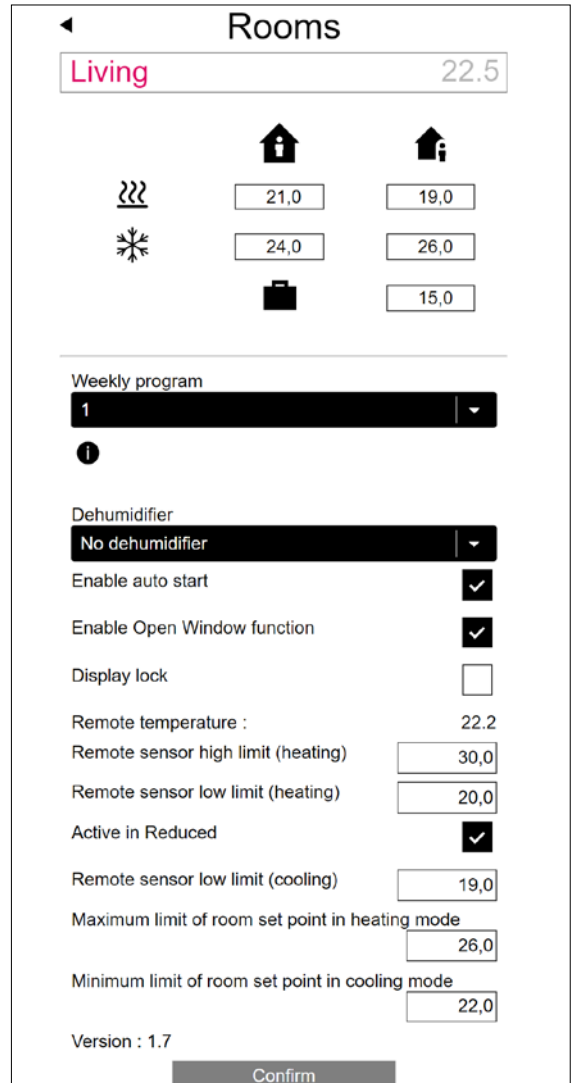

Fig. 06-6 Web page: Extended room page settings

The standard values for heating / cooling can be managed here for "NORMAL" or "REDUCED" mode as well as for holiday mode.

There are five weekly programs available. By clicking the info symbol, you will see a preview of the selected timer program.

The auto-start function ensures that the desired room temperature is reached at the defined point in time. If the auto-start function is not selected, the room is only heated or cooled to the new default value from the point at the time selected in the timer program.



Rooms that are also equipped with a fan coil should always be operated with the activated autostart function. The autostart function gives the surface heating / cooling system the opportunity to bring the room to the desired temperature according to the timer program in the most energy-saving and also silent

manner without starting the fan coil prematurely. Using the display lock, the operation of the room unit can be blocked.

If a floor temperature sensor is installed, the limit values to be observed for heating and cooling mode can be specified.

**06.05 Timer programs**

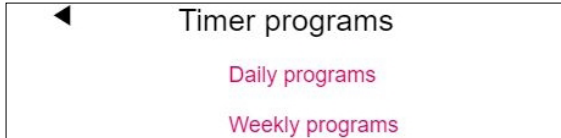

Fig. 06-7 Web page: Timer programs

There are 5 weekly programs and 10 daily programs.

The daily programs that can be defined in a 15 minute time grid. The displayed sections are rounded to one hour. The areas marked in red indicate the periods of time defined for "NORMAL" mode.

For each day of the week, a different daily program can be chosen.

The weekly programs are applied for the room temperature set points, for the fan coils and for the dehumidifiers.

**Note:**

A number of programs are predefined but can be changed at any time. Based on the selection of the building type (residential building, office building), the appropriate timer programs are selected automatically.



Fig. 06-8 Web page: Daily program selection

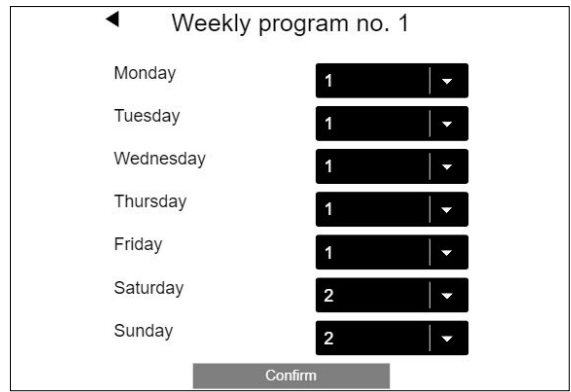

Fig. 06-9 Web page: Weekly program selection

**Daily program set up**

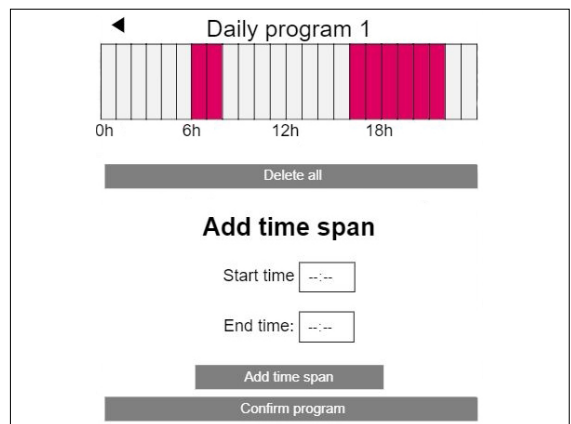

Fig. 06-10 Web page: Set up daily program

The standard program for working days is defined as follows for residential buildings:

Normal mode from 6 h to 8 h and from 16 h to 22 h.

The rest of the day is reduced mode.

All normal mode time spans can be deleted, additional time spans can be added.

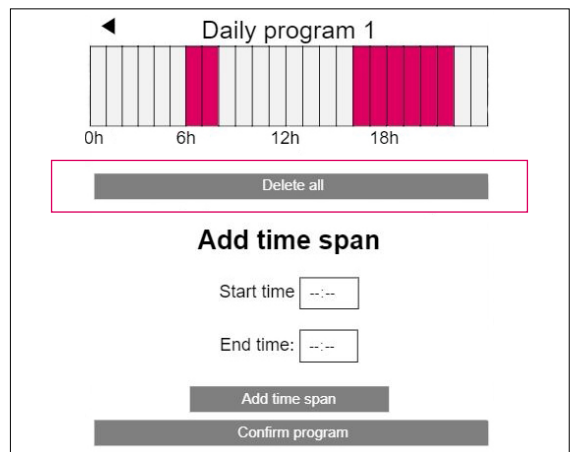

Fig. 06-11 Web page: Set up daily program, delete

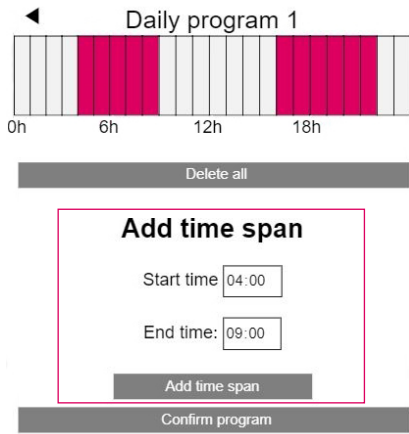

Fig. 06-12 Web page: Set up daily program, new time span

After confirmation the time span in the morning is enlarged.

**Note:**

When "Auto start" function is enabled in room configuration, the system tries to reach the set points for normal mode in time at the begin of the defined time period.

The time span determined for the autostart function is continuously updated.

During this period, fan coils continue to work with the value specified in the time program in order to give priority to the other systems.

**06.06 System**

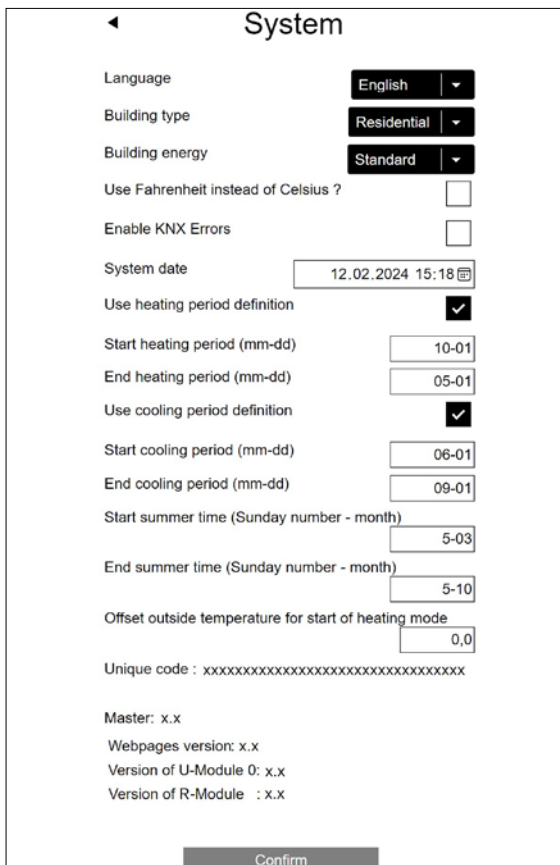

Fig. 06-13 Web page: System

On the system page, you can make additional settings:

- Language
- Building type (residential or commercial)
- Classification of the building's energy requirements
- Time and date
- Determination of permissible times for heating and cooling mode
- Changing the start-up criteria for heating mode

**Note:**

Depending on the present system, some standard values may not be effective.

**06.07 Dehumidifier settings**

Dehumidifiers are required depending on climatic conditions. The dehumidifiers are assigned to individual rooms and are controlled via timer programmes.

The limit values for switch-on (relative humidity, calculated dew point) and the assignment to timer programmes can be defined in the menu "Dehumidifier settings".

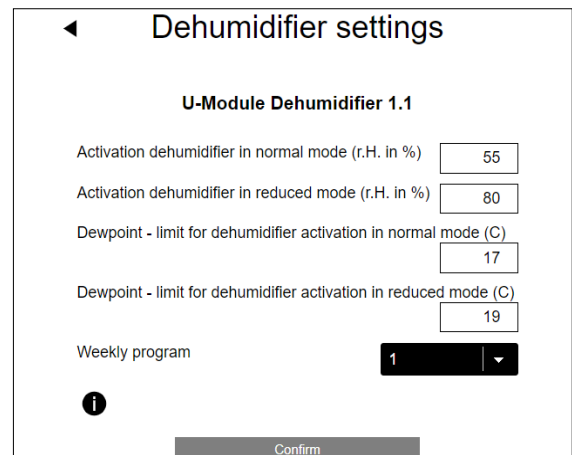

Fig. 06-14 Web page: Dehumidifier

The weekly program switches between normal and reduced operation, same as it is with the setpoints for the room temperature. The reduced operation, usually during the night, reduces the impairment caused by the inevitable operating noise of the devices.

The values for reduced operation have therefore been intentionally chosen in such a way that in this phase the dehumidifiers are only started when it cannot be avoided.

Default values of relative humidity:

- normal operation: 55 % r.H.
- reduced operation: 80 % r.H.

The relative humidity indicates the extent to which the air is saturated with moisture. Too high humidity is perceived as unpleasant, and it can even lead to condensation on cool surfaces. Too low humidity can lead to skin irritation and breathing problems.

A humidity in the range of 40 % to 60 % is ideal. The setting value for the reduced operation is therefore the absolute upper limit, which should not be exceeded.

Default values of dew point:

- normal operation: 15 °C
- reduced operation: 17 °C

The dew point indicates at which surface temperature condensation occurs on this surface (at the current relative humidity). In a radiant cooling system, the cooled surfaces have a temperature of about 17 °C to 23 °C, depending on type of installation and settings. In order to avoid condensation on these surfaces, again, the limit value for reduced operation is the absolute upper limit.

## 06.08 IT settings

Fig. 06-15 Web page: IT settings

### 06.08.01 Connection to a router via WIFI

Here settings are made that allow the master base of the NEA SMART 2.0 system to connect to the router via WIFI.

#### Router SSID:

Insert WIFI network name (Network SSID) of the router.

#### Router password:

Insert password (WPA2-Key of WIFI network) of the router.

The system must be connected to the Internet in order to use the NEA SMART 2.0 App.



#### WPS:

There is a WPS function available which does not require manual input of router SSID and router password – see chapter 07.02.03

### 06.08.02 Direct WIFI connection to an external device via access point (AP)

When the transmitting function of the NEA SMART 2.0 Base is activated via access point (AP), the WIFI network transmitted by the base is visible to every user – similar to the WIFI network of a router.

A security key (WIFI WPA2 key) is necessary for setting up an access point (AP). It is recommended to change the default security key (default WIFI WPA2 key) during the initial setup.

#### Password for access point (AP) mode:

For changing the WPA2-Key of the REHAU NEA SMART 2.0 access point (AP) network insert a new WPA2-Key (password).

#### Confirmation password for access point (AP) mode:

Insert the new WPA2-Key (password) for confirmation.

If the password has been forgotten, it can be reset to the delivery status.

#### Reset WPA2-Key (password) for access point (AP) to default setting

- Press < and > for 3 secs
- LED "WIFI" is flashing, independent of previous state of WIFI
- Press <, OK and > for 10 secs

As a confirmation of successful reset of WIFI key the LED of WIFI / LAN and AP are blinking alternating for 5 secs.

## 06.09 Fan coils

In the user area of the web page, settings can be made for switched fan coils and modulating RAUCLIMATE SILENT BREEZE fan coils for each room.

Master - 1	22.6
Master - 7	21.6
Master - 10	21.7

### 06.09.01 Basic Settings

Depending on the room configuration different displays appear on the room page.

#### A) Room without Fan Coil

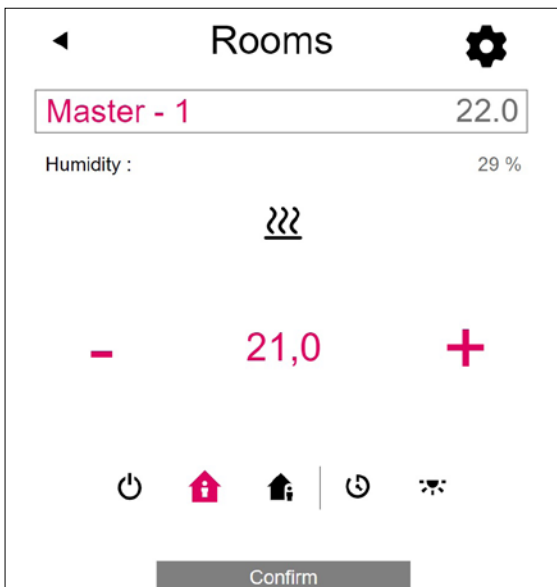

#### B) Room with switched Fan Coil

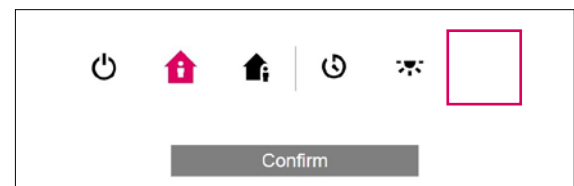
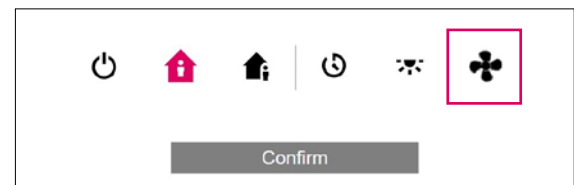
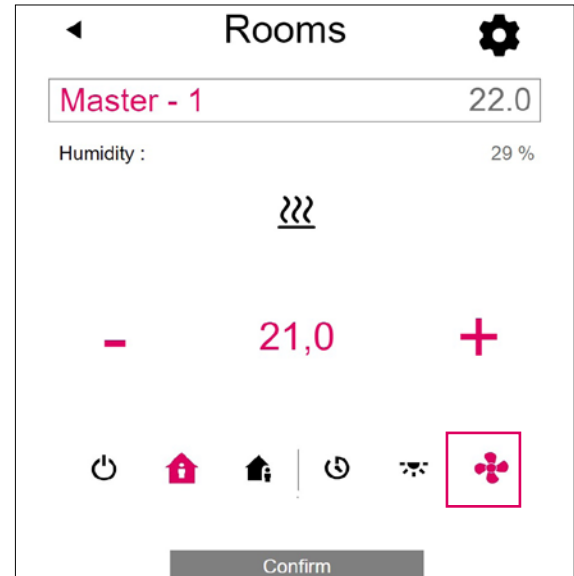

- The „Fan coil Symbol“ button can be used to manually start and stop the switched fan coil. The button indicates the operating status (red = fan coil in operation).
- A missing „Fan coil Symbol“ button indicates that the switched fan coil is permanently deactivated (switched off). The deactivation is done via the checkbox „Fan coil lock“ in the advanced settings or via the room unit (Fan coil ON / OFF).

**C) Room with up to four modulating RAUCLIMATE SILENT BREEZE fan coils also in combination with one switched fan coil**

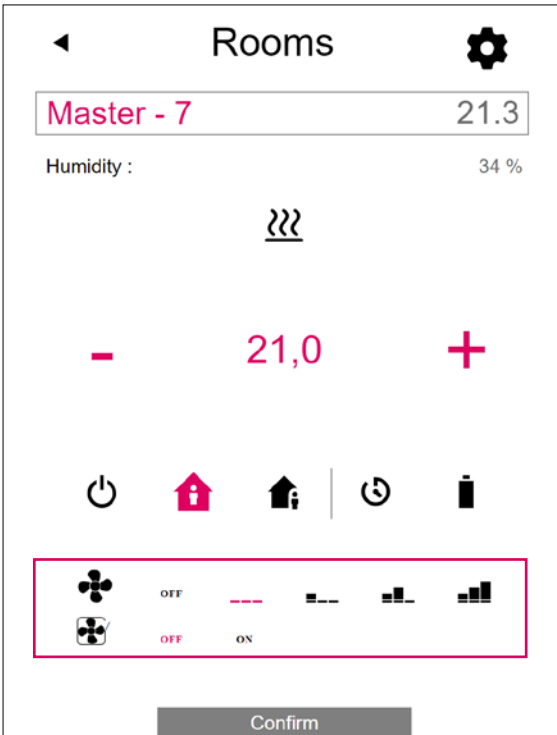

- Changing fan coil operation mode

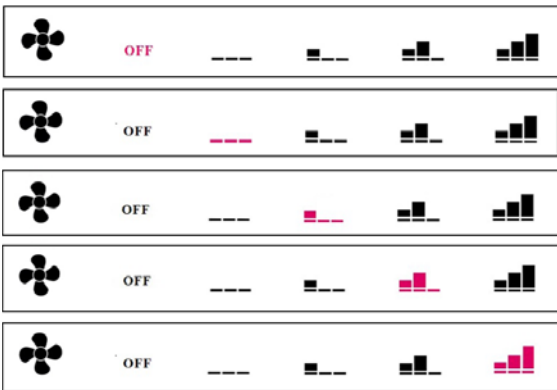

- OFF
- STANDBY
- MIN – lowest fan speed
- MED – medium fan speed
- MAX – highest fan speed

- Display operating status (red fan coil symbol = fan coil in operation)

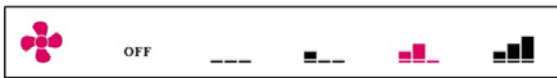

- Activation of the fan coil flap (OFF / ON) to switch between oscillating and directional airflow when using a RAUCLIMATE SILENT BREEZE fan coil with flap

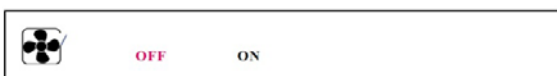

Switched fan coils and RAUCLIMATE SILENT BREEZE fan coils are in the setting

- OFF permanently disabled
- STANDBY deactivated until the next switching point of a time program arrives or the energy level is manually changed. In this case the default setting for energy level REDUCED / NORMAL is applied.

RAUCLIMATE SILENT BREEZE Fan coils are in the setting

- MIN / MED / MAX operated in the selected mode until the next switching point of a time program arrives or the energy level is manually changed. In this case the default setting for energy level REDUCED / NORMAL is applied.

Without the use of timers, the fan coil remains in the selected energy level.

## 06.09.02 Advanced Settings

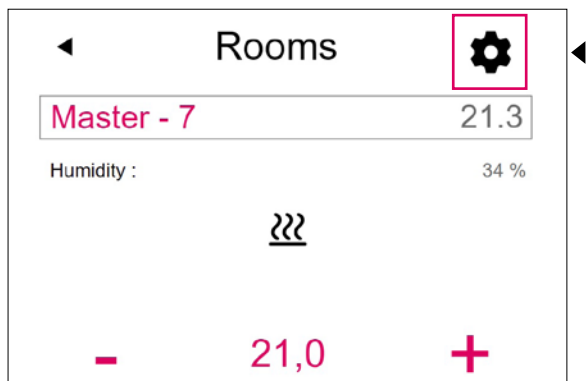

Depending on the room configuration, different setting options appear.

## A) Advanced Settings for Switched Fan Coil

1 Selection Fan coil Tolerance: ECO, NORMAL, COMFORT.

Fan coil starts when the room temperature at ECO 1.5 K / NORMAL 1 K / COMFORT 0.5 K deviates from the set point.

2 Fan coil locks for permanent deactivation of switched fan coils. If the check box is selected, the fan coil is locked.

3 Fan coil active in reduced: When checkbox is activated, fan coil works also in reduced mode

**B) Advanced settings for modulating  
RAUCLIMATE SILENT BREEZE fan coils also  
in combination with one switched fan coil**

**Rooms**

Master - 10 21.6

21.0 19.0

24.0 26.0

15.0

Weekly program  
1

Dehumidifier  
No dehumidifier

Enable auto start

Enable Open Window function

Display lock

1 Fan coil Tolerance  
ECO

2 Fan coil Lock

3 Comfort Cooling PLUS

4 MAX for Fan n° 1  
MAX

MAX for Fan n° 2  
MAX

5 Fan coil preset Normal  
MED

Fan coil preset reduced  
MIN

Maximum limit of room set point in heating mode 26.0

Minimum limit of room set point in cooling mode 22.0

Version : 1.7

Confirm

1 Selection Fan coil tolerance: ECO, NORMAL, COMFORT.

Fan coil starts when the room temperature at ECO 1.5 K / NORMAL 1 K / COMFORT 0.5 K deviates from the setpoint.

2 Fan coil lock for permanent deactivation of switched fan coils and modulating RAUCLIMATE SILENT BREEZE fan coils. If the checkbox is checked the fan coil is blocked.

3 Comfort Cooling PLUS to increase comfort in unpleasantly high humidity conditions for RAUCLIMATE SILENT BREEZE fan coils.

4 Max for fan n°:  
Selection of the maximum possible air speed (MIN, MED, MAX) for RAUCLIMATE SILENT BREEZE fan coils. The RAUCLIMATE SILENT BREEZE fan coils assigned to the room are listed individually (maximum 4) and can be individually adapted.

5 Fan coil Preset Normal / Reduced: Preset of the fan stage (STANDBY, MIN, MED, MAX) in energy level REDUCED and NORMAL for RAUCLIMATE SILENT BREEZE fan coils.



If STANDBY is selected under Default Settings, switched fan coils and RAUCLIMATE SILENT BREEZE fan coils are deactivated in REDUCED and / or NORMAL operation in the basic state. This setting can be temporarily overridden on the main room page – until the next switching point of a time program arrives.

## 06.10 KNX

The KNX connection of the NEA SMART 2.0 system is suitable for exchanging data (setpoints, actual values, operating modes and energy levels) between the NEA SMART 2.0 system and a higher-level KNX system, e.g. BMS. This connection is made using the NEA SMART 2.0 KNX gateway that communicates with the NEA SMART 2.0 system via the SYSBUS. The assignment between KNX objects and Modbus registers can be configured using parameters in the ETS software (license software for KNX). No further software is absolutely necessary. The SYSBUS (Modbus) assignment required for the REHAU NEA SMART 2.0 control system can optionally be imported to the gateway via DCA (Device Configuration App, SW extension in the ETS). The SYSBUS (Modbus) assignment can be imported for a KNX installation in the office or on the construction site.



## 07 Usage of the NEA SMART 2.0 App

The NEA SMART 2.0 App can be found in the google® Play Store and apple® App Store.

### 07.01 Using the App

No matter where you are, the NEA SMART 2.0 App offers you a wide range of options for operating and monitoring your system.

Via App, you can:

- Assign names to the rooms and set the desired temperatures
- Create timer programmes for the desired temperatures and assign them to the rooms
- Select the energy levels "normal mode" and "reduced mode" for all rooms or individual rooms
- Use the holiday function
- Automatically save energy when nobody is at home
- Switch between operation mode heating and cooling
- View evaluations and statistics
- Receive notes regarding upcoming maintenance work
- Operate fan coils



In order to be able to use the App, the system must be registered on the REHAU cloud server.

For this purpose, the base station must be connected to the router via WIFI or LAN and via the router to the Internet.

In order to connect the base to the WIFI router, the router SSID and the security key must be entered on the web page under IT settings.

The integrated web pages (chapter 05) cannot be used in this operating mode.

### 07.02 Setting up the base for connecting to the internet and using the App



For systems in which there is more than one base, communication always takes place via the "master" base. Ask your installer which base has been established as the master.

When the system is delivered, the communication functions of the base station via WIFI and LAN are switched off.



The NEA SMART 2.0 Base may only be handled if the cover is in place on the NEA SMART 2.0 Base. If this is not the case, the installer has to be called.

---

**07.02.01 Establish a LAN connection to the internet**

**Activating communication at master base**

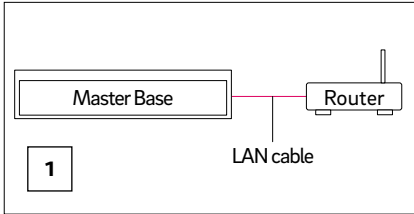

1 Connect the NEA SMART 2.0 Base with the router / network via LAN cable.

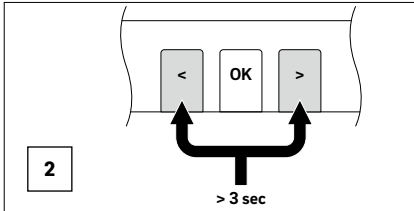

2 Press both arrow buttons < > at the same time for > 3 seconds.

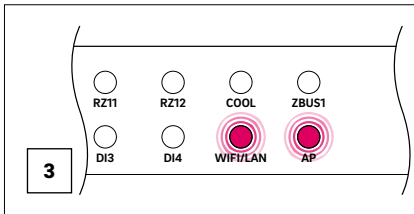

3 The WIFI / LAN LED and / or the AP LED will begin to flash.

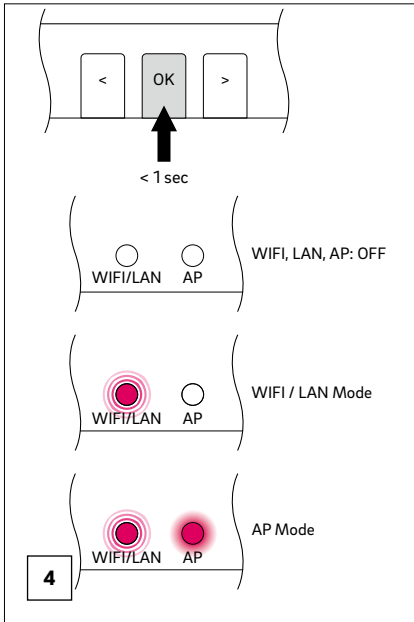

4 Confirm by briefly pressing the OK button. The current status of the transmitting function is displayed.

- WIFI / LAN, AP: OFF
- WIFI / LAN (server connection) mode
- AP (direct connection) mode

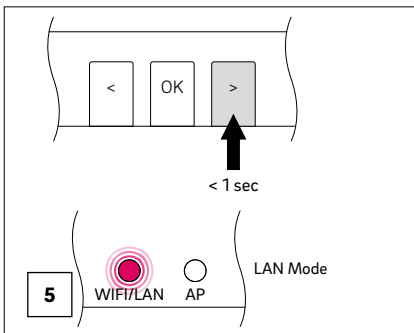

5 By briefly pressing the < or > button, it is possible to switch between the transmitting functions.

Press the < or > button repeatedly until  
→ LAN mode is preselected.

In this case, the WIFI / LAN LED flashes fast and the AP LED is off.

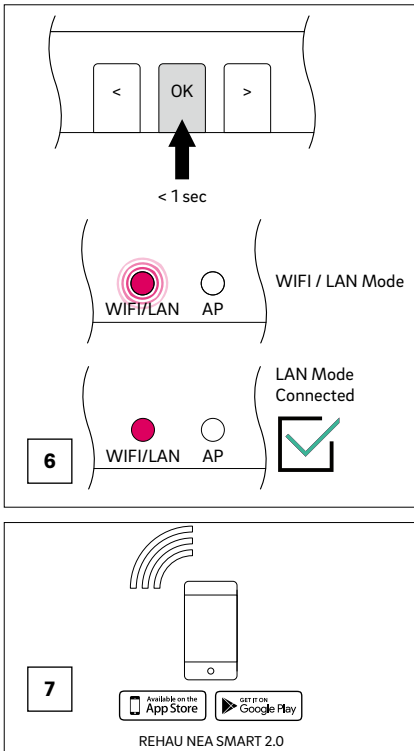

6 Confirm by briefly pressing the OK button.  
 In this case, the WIFI / LAN LED flashes slowly and the AP LED is off  
 → LAN mode is activated

The NEA SMART 2.0 Base is now ready for LAN connection to a router.

The WIFI / LAN LED will start to light up permanently after no more than 2 minutes.

The base station is now connected to the Internet and the REHAU server.



If no buttons are pressed for a certain time, the NEA SMART 2.0 Base will return to the initial state. In this case, the sequence for activating the transmitting function can be started again.

7 The App can now be connected as described below in section „Setting up the NEA SMART 2.0 App“.

**07.02.02 Establish a WIFI connection to the Internet**

**Setting access data of WIFI network**

In order to connect the base to the Internet via WIFI, it is necessary to enter the access data (SSID and WPA Key) of the WIFI network of the router.

- Get to the input field for the access data on the web page "IT settings" described in chapter 05
- Enter the SSID and the password (WPA key) of the WIFI network in the input fields
- Confirm the entry

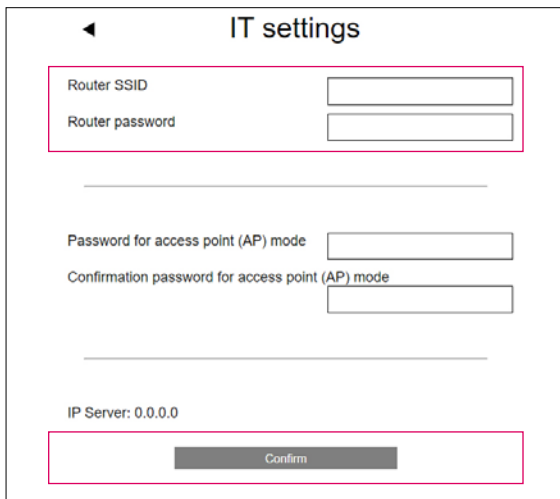

**Activating communication at master base**

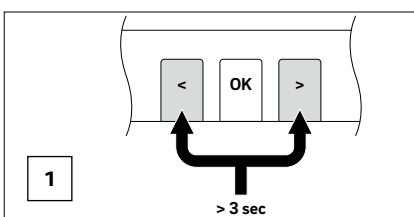

1 Press both arrow buttons < > at the same time for > 3 seconds.

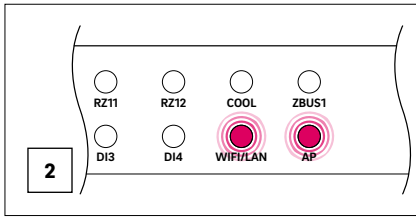

2] The WIFI / LAN LED and / or the AP LED will begin to flash.

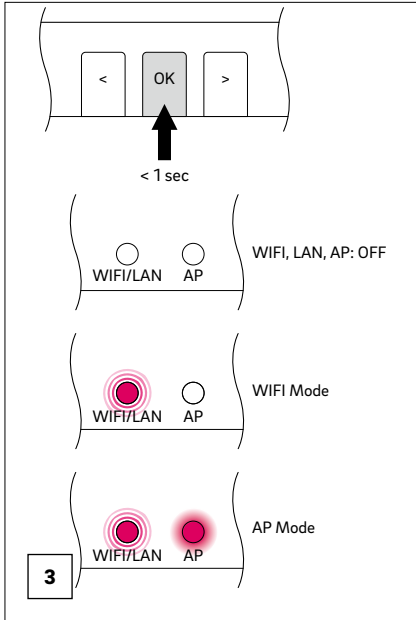

3] Confirm by briefly pressing the OK button. The current status of the transmitting function is displayed.

- WIFI / LAN, AP: OFF
- WIFI / LAN (server connection) mode
- AP (direct connection) mode

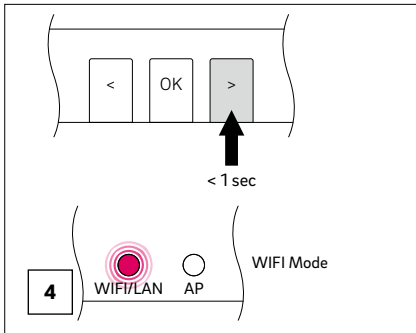

4] By briefly pressing the < or > button, it is possible to switch between the transmitting functions.

Press the < or > button repeatedly until  
→ WIFI mode is preselected.

In this case, the WIFI / LAN LED flashes fast and the AP LED is off.

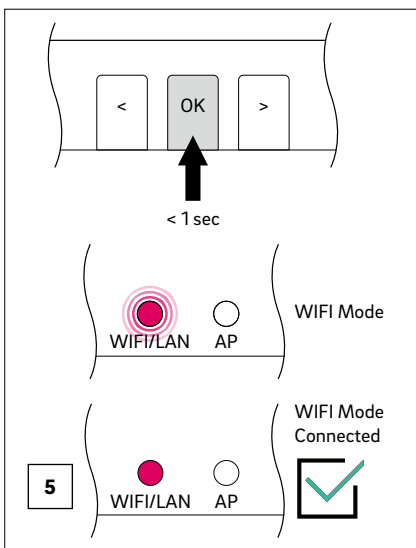

5] Confirm by briefly pressing the OK button.

In this case, the WIFI / LAN LED flashes slowly and the AP LED is off  
→ WIFI mode is activated

The NEA SMART 2.0 Base is now ready for WIFI connection to a router.

The WIFI / LAN LED will start to light up permanently after no more than 2 minutes with the IT Settings configured on the corresponding web page (see chapter 05).

The base station is now connected to the Internet and the REHAU server.



If no buttons are pressed for a certain time, the NEA SMART 2.0 Base will return to the initial state. In this case, the sequence for activating the transmitting function can be started again.

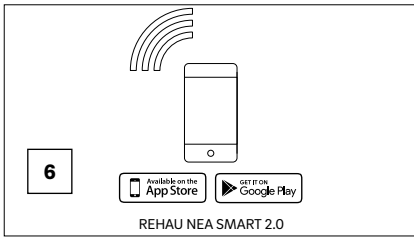

6 The App can now be connected as described below in section „Setting up the NEA SMART 2.0 App“.

**07.02.03 WPS – Establish a WIFI connection to the Internet via WPS**

The WPS functionality is an easy way to establish a WIFI connection between router and base.



WIFI router, repeater must support WPS.

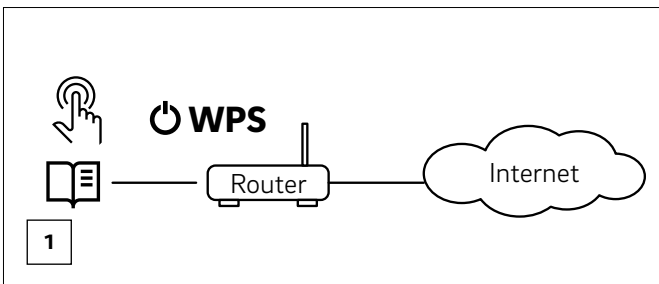

1 Switch on the WPS function of your router.



- Please read the manual for activation of the WPS function of your router. The WPS function is active for a certain time span.
- Deactivate MAC address filter at router.

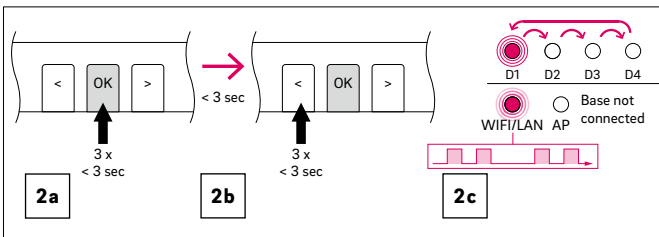

2 The WPS activation is possible by pressing 3 x „OK“ and afterwards 3 x „<“



2 min



- The WPS function is active for 2 minutes. During this timespan a running light is visible
- From software-version V 2.0.

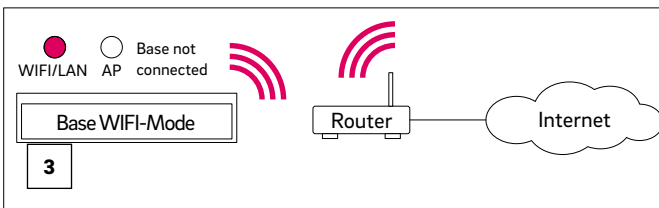

3 The base is connected to the Internet and the REHAU server when the WIFI / LAN LED will start to light up permanently.



### 07.03 Setting up the NEA SMART 2.0 App

After the Base is successfully connected to the Internet as described in the previous chapter, the App can be connected. The App can be downloaded as an App for iOS or Android in the respective App stores. The steps following the installation of the App are described below.

1. After opening the App, the start screen Appears. A personal account must be set up under the "Create account" menu item.

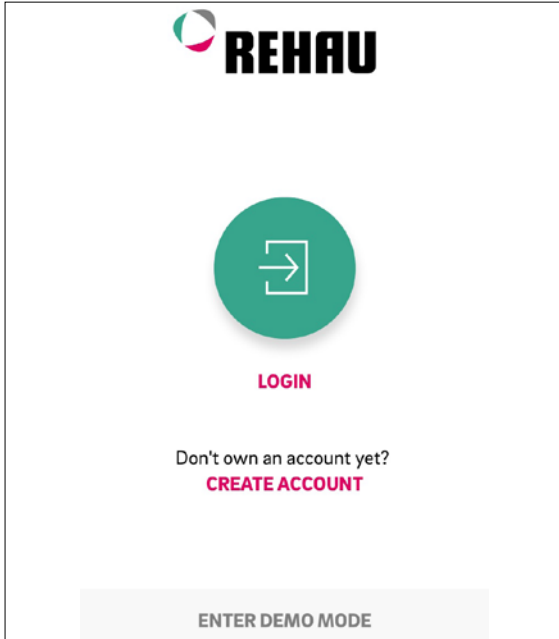

Fig. 07-1 App: Login page

2. You are required to enter your name, email address and specify a password. The password must be at least 10 characters long, contain at least one upper-case and one lowercase letter, a number and a special character.

The "Privacy Policy" and "Terms and conditions" are confirmed by checking the box. You can read through the "Privacy Policy" and the "Terms and conditions" by clicking the text highlighted in red.

Then confirm by clicking "Sign up"

Fig. 07-2 App: Create a new REHAU account

3. Upon successful completion of the registration, the base must be registered with the App.

There are two ways to do this:

- Scanning the QR code that is printed on the base or
- Entering the identification number
- Afterwards press "PAIR DEVICE"

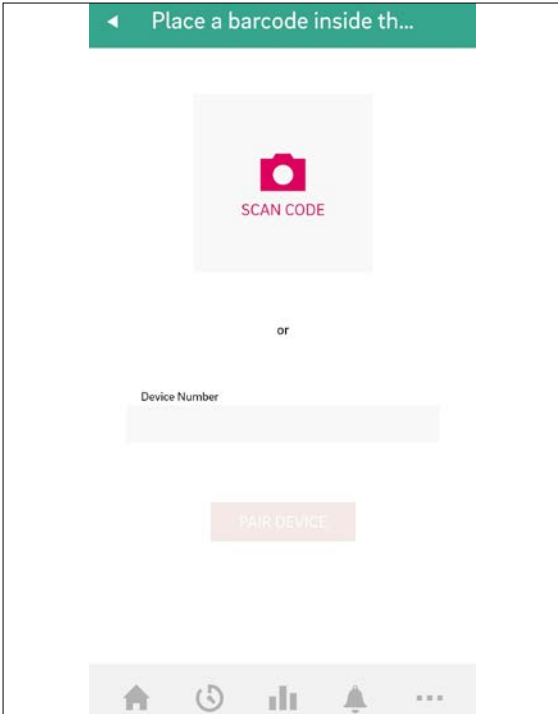

Fig. 07-3 App: Connecting the Base

4. Confirm by briefly pressing the OK button of the master base as soon as the following request Appears in the App.

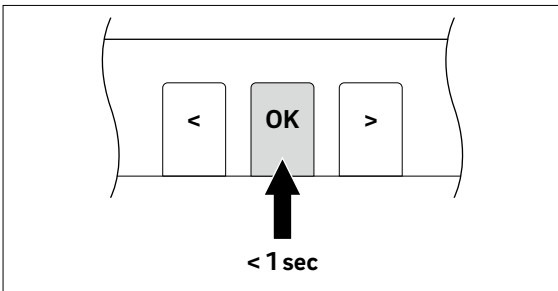

Fig. 07-4 App: Confirm

5. The overview screen (HOME screen) of the App opens, and the individual rooms are displayed. The App can now be used.

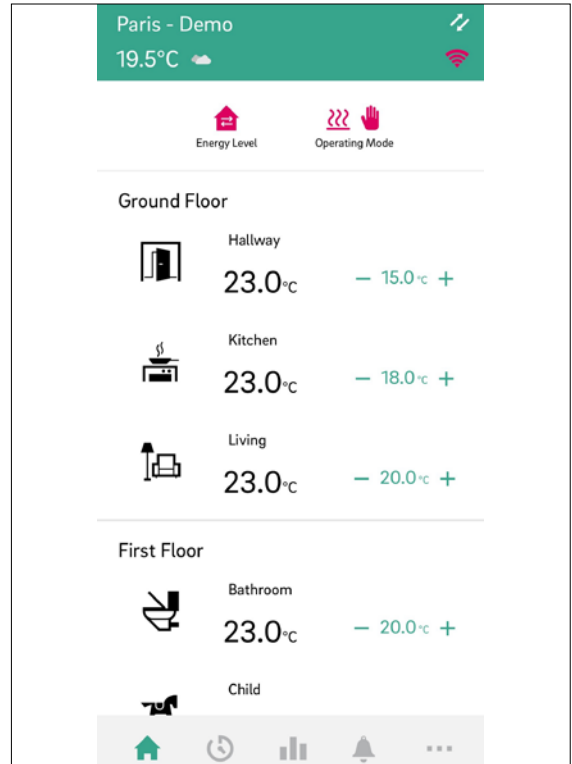
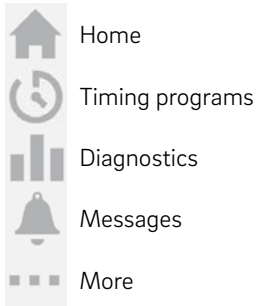

Fig. 07-5 App: Overview rooms

## 07.04 Getting to know the App

After successful pairing of App and NEA SMART 2.0 installation, the App will show the Home screen with all the rooms of your installation. The main navigation bar at the bottom of the screen guides you through the four main areas of the App:



### 07.04.01 Home

The Home screen displays (from top to bottom)

- Name of the installation
- Current weather information
- Information on WIFI /LAN connection
- Information on current energy level and operating mode
- Overview of all rooms
- Main navigation bar

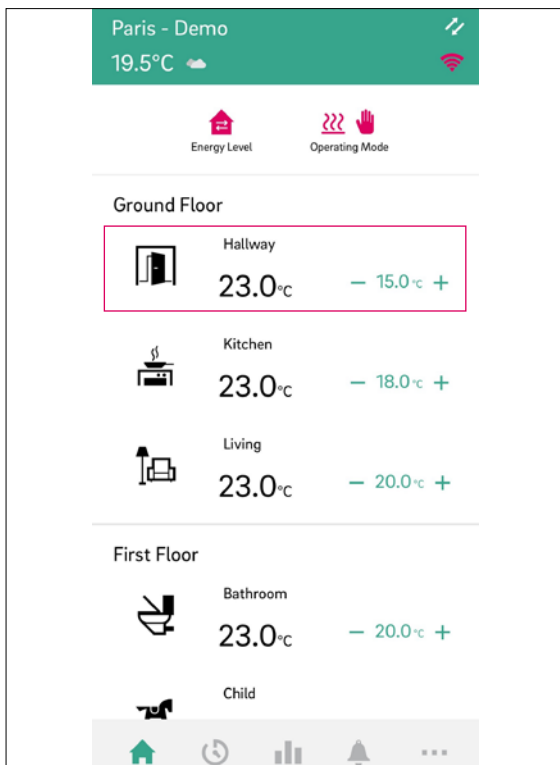

Fig. 07-6 App: Home screen

### 07.04.02 Room page

A tap on a room opens the room page with detailed information about

- Operation mode
- Actual room temperature
- Actual humidity in the room in case of room units and probes with humidity measurement
- Setpoint temperature
- Energy level

Each room can be personalized with an own name and an icon.

The rooms will be named by default Master-1, Master-2 and so on unless they have been given names already during the set up on the web pages of the NEA SMART 2.0 installation.

To change the name of the room via App, choose the room in the main screen. The main room screen will be displayed.

Push the three dots on the upper right part of the screen and choose "Settings" and then "General" to get to the screen to change name and icon of the room.

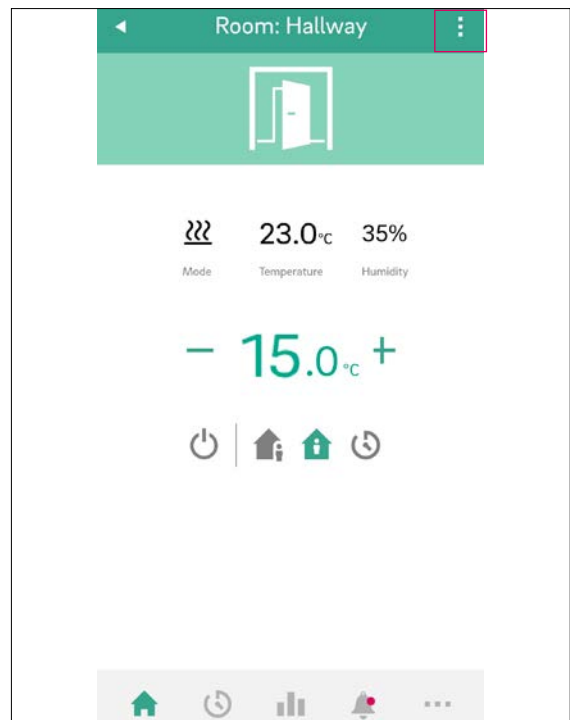

Fig. 07-7 App: Room page

### 07.04.03 Energy Level for rooms

Rooms can have the following energy levels:

- Timed mode: rooms will follow the timing programs assigned to this rooms and will switch automatically between normal and reduced mode
- Normal mode: rooms will follow the set point that has been set for normal mode



- Reduced mode: rooms will follow the set point that has been set for reduced mode
- Standby: Rooms will not follow any set point. Only frost protection is active and rooms will be heated, once their temperature drop below 5 °C by default - adjustable during commissioning.
- Vacation: Rooms will follow the set point that has been given for vacation.
- Party: Room will follow the set point for normal mode for the time chosen for party mode.



Fig. 07-8 App: Energy level

**07.04.04 Operating Mode**

The operating mode is valid for the complete NEA SMART 2.0 installation. There are five different choices:

- Auto: NEA SMART 2.0 changes automatically between heating, cooling or neutral operating mode depending on outside conditions, rooms conditions and heating / cooling periods (if defined).
- Heating: NEA SMART 2.0 will heat only, depending on the room conditions, outside conditions and heating period (if defined).
- Manual Heating: NEA SMART 2.0 will heat depending on the room conditions, regardless of any heating period or outside condition.
- Cooling: NEA SMART 2.0 will cool only, depending on the room conditions, outside conditions and cooling period (if defined).
- Manual Cooling: NEA SMART 2.0 will cool depending on the room conditions, regardless of the cooling period and outside condition.



Auto Mode and Cooling / Cooling Manual is only available if your NEA SMART 2.0 system is configured for cooling. The heating and cooling modes can also be enabled or disabled depending on the control signals applied to the system.



Fig. 07-9 App: Operating mode

**07.04.05 Set points for temperature in timed mode**

For each room, there can be a set point defined for normal mode and reduced mode. To change these set points, choose the individual room in the start screen, push the three dots on the upper right part of the screen and choose "Settings" and then "Set points Room Temperature". In this screen, the set points can be adjusted.

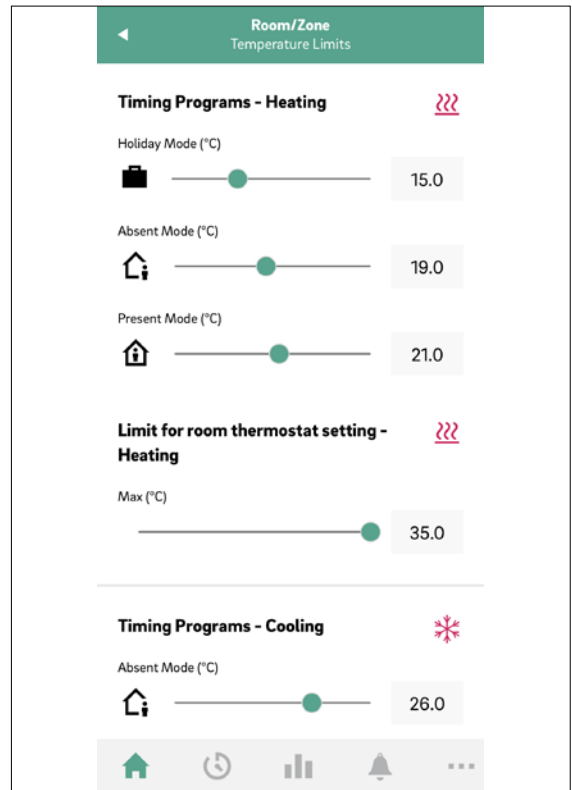

Fig. 07-10 App: Set points for temperature in timed mode

**07.04.06 Advanced Menu**

A tap on the 3 dots near the room name opens the menu with the contents

- Settings
  - General
  - Set points room temperature
  - Open window detection
  - Timing programs
- Activate Party Mode (party mode 2 hrs, 4 hrs, until manual deactivation)
- Lock Room Unit

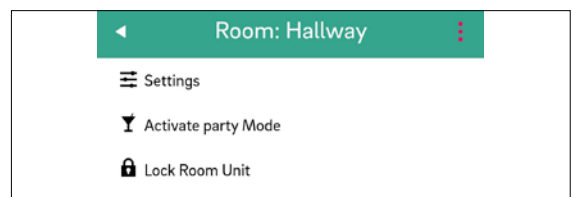

Fig. 07-11 App: Advanced menu

**07.04.07 Timing programs**

The Timing program screen displays

- Daily plan, Weekly plan, Vacations, Party
- Main navigation bar

NEA SMART 2.0 offers the option of creating five different weekly programs. These weekly programs can be combined from ten different daily programs. Each room can get assigned:

- One of the five weekly programs
- An even more customized timing program where every room has its individual day-by-day program

To define the daily programs, go to "Timing programs" in the main menu bar. The daily plans are shown and can be adjusted. The option "Weekly Program" gives the possibility to combine the daily programs to a weekly program. The weekly program can be assigned to individual rooms when pushing the "+" button at the bottom of the "Weekly program" screens.

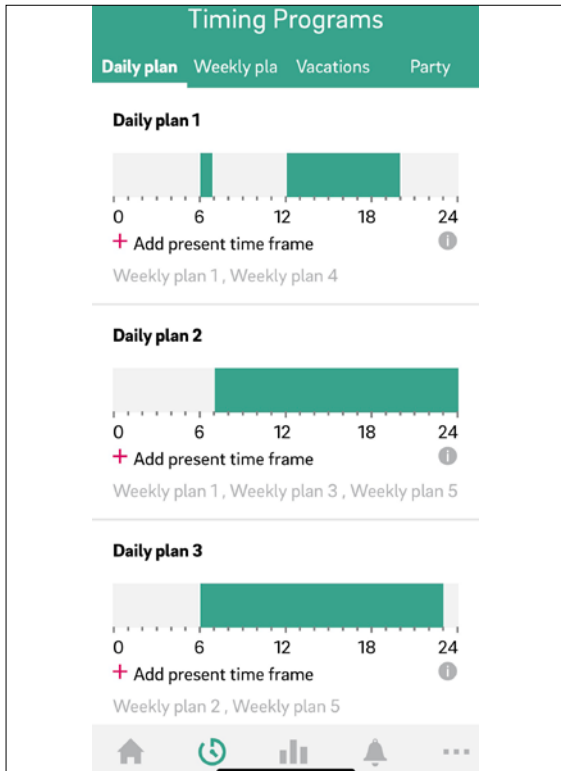

Fig. 07-12 App: Timing programs screen

**07.04.08 Diagnostics**

The Diagnostics screen displays (from top to bottom)

- Position of users (if activated)
- Different tiles to display statistics and information
  - Room list (rooms displayed in tiles; tap on a tile opens temperature and humidity graph of the selected room; tap on the info icon shows battery status of battery powered room units or probes)

- Outside temperature graph
- Open window information
- Battery status information
- Main navigation bar

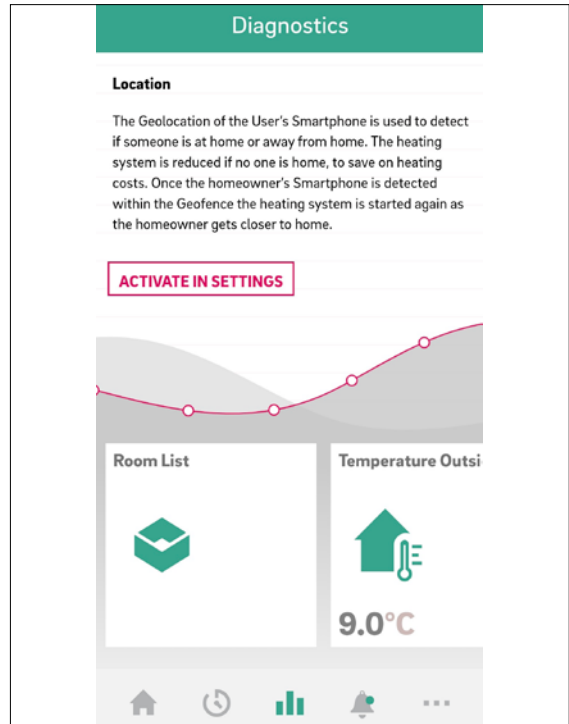

Fig. 07-13 App: Diagnostics screen

**07.04.09 Messages**

The Messages page shows alarms, warnings and general information about system events. The messages can be filtered, e.g. so that only new messages are displayed.

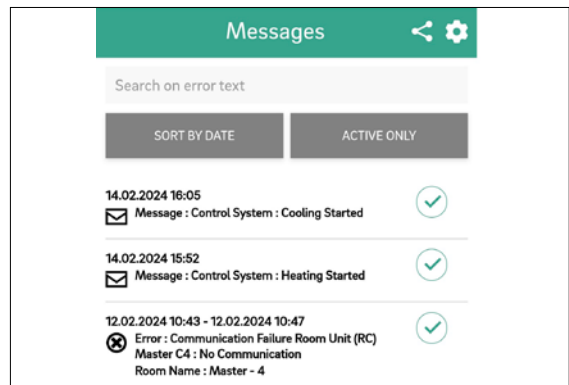

Fig. 07-14 App: Message screen

**07.04.10 More**

- The More screen displays (from top to bottom):
- Account Management (personal information; listing and selection of all paired buildings / apartments)
  - Settings (language; units; software-update; heating / cooling settings; date / time; geofencing; installer area)
  - Rooms / Zones (Grouping of rooms into zones). Create zones and include rooms In some cases, several rooms may be put into one zone, e.g. main floor and first floor. To do so, got to "More" in the main screen, then chose "Rooms / Zone". New zones can be created after pushing the "Plus" icon. Rooms can be added to a zone once the new zone is created
  - Pop up / Push Notification Management (errors, warnings and messages setup)
  - Legal (terms of use; data protection; open source components)
  - Help (link to NEA SMART 2.0 Manager – information portal)
  - Explore REHAU (link to REHAU homepage www.rehau.com)
  - Icon to change between installations (only if more than one installation is linked to the account)

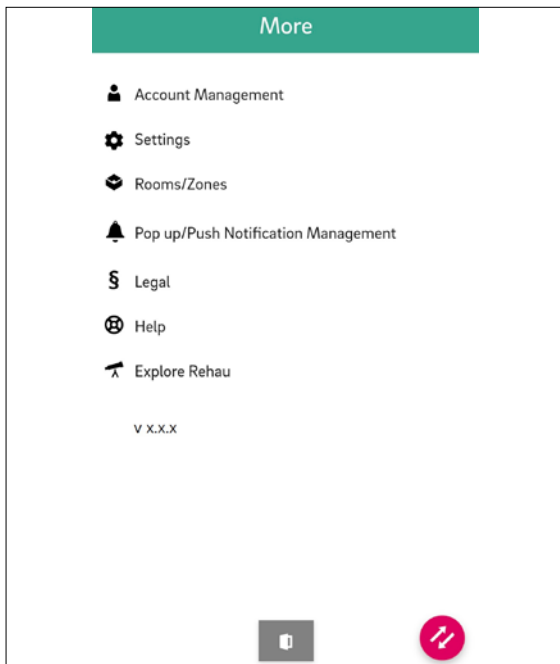

Fig. 07-15 App: More screen

**07.04.11 Display weather data for the location of the installation and enter contact data**

In order to display the weather data for the location of your installation, the location must be stored. Additionally the contact data can be entered.

To do this, go to the following page of your App:

- More > Account management > Buildings / Apartments > Installation > select your installation or
- via the Home screen by tabbing on the Installation name in the upper area

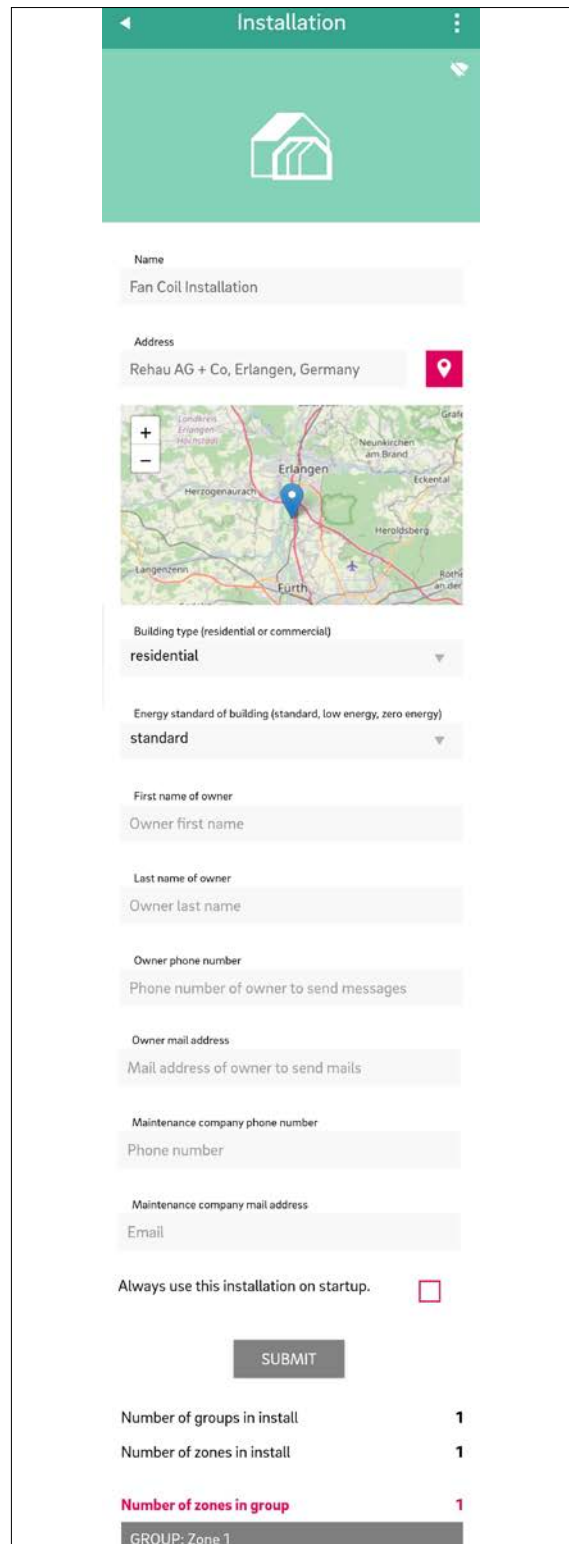

Fig. 07-16 App: Location of installation

#### 07.04.12 Smart function Geofencing

The Geolocation function of the User's Smartphone is used to detect if someone is at home or away from home. To use the function, the position of the installation must be known. For this purpose, the installation for which the location is to be set must be selected under More → Account Management → Buildings / Apartments. If the location function of the used smart device is activated, the location button can be clicked. This can be found next to the address line. The current location of the used device is entered.

The heating system is reduced if no one is home, to save on heating costs. Once the homeowner's Smartphone is detected within the Geofence the heating system is started again as the homeowner gets closer to home.

Geofencing is a useful function if all home users have a smart phone and usually carry it with them when they leave home. It only works for rooms that are in timed mode. If the room is in timed mode "Normal" and no one is at home, the room will be switched to Reduced mode.

Geofencing should not be activated on tablets that stay at home.

**07.04.13 Automatic update of the NEA SMART 2.0 App (OTA)**

In order to have the latest version of the App on your devices, we recommend activating the button for automatic updates (OTA).  
More > Settings > General

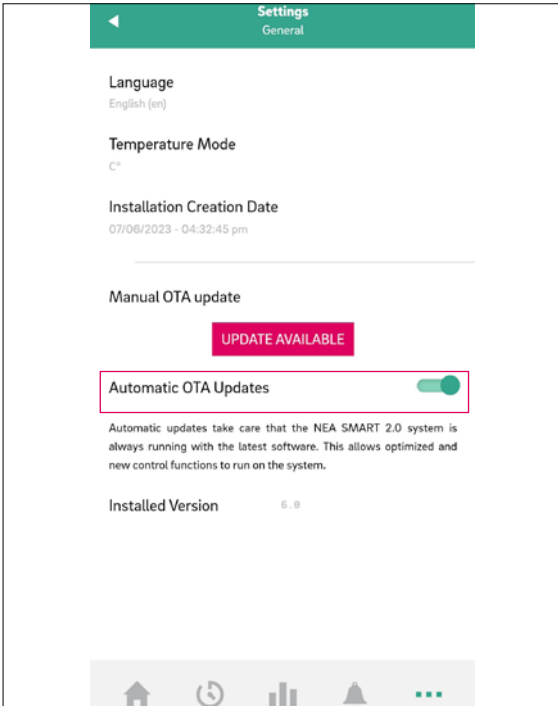

The software for the NEA SMART 2.0 system is continuously being developed and improved. An update via an internet connection is required to take advantage of all new and improved functions.

Fig. 07-17 App: Automatic updates

**07.04.14 Update the display of the NEA SMART 2.0 App**

It can happen that the App does not display the latest data from the Room units etc. A quick and easy update is necessary to bring the App up to date.

To do this, pull the green weather bar from top to bottom, the App will then update automatically indicated when weather bar changes to red and changes back to green again. A confirmation will be displayed at the end.

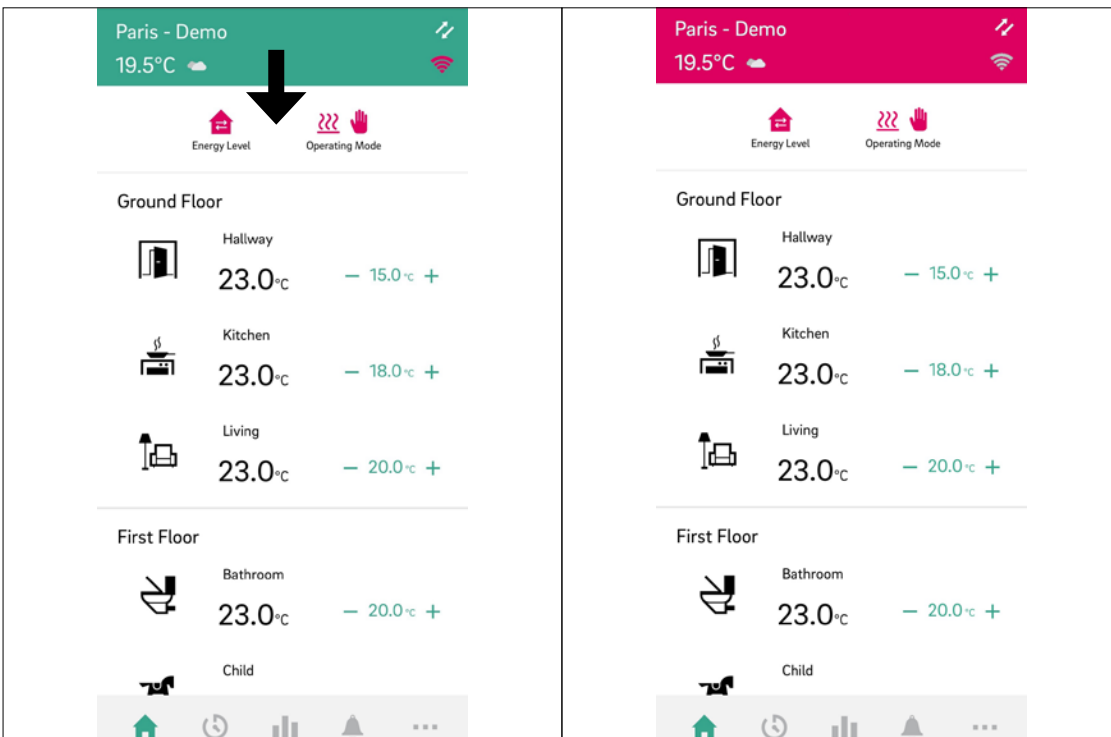
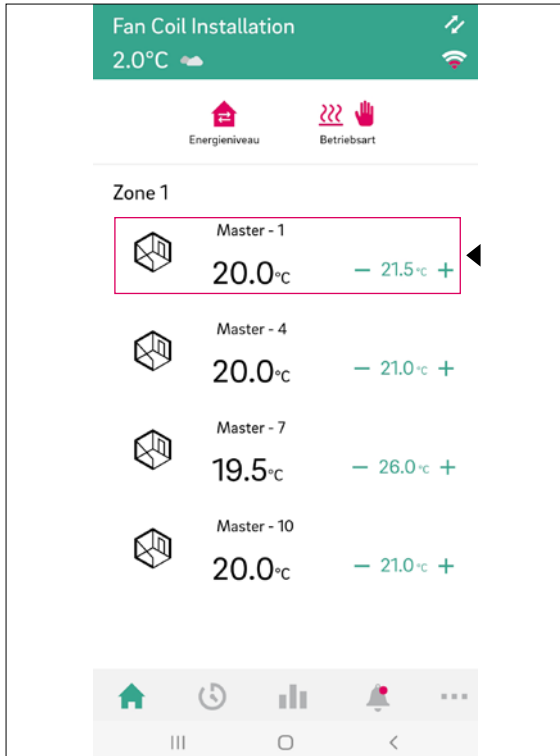

Fig. 07-18 App: App update

**07.05 Using fan coils**

In the user area of the App, basic settings for switched fan coils and modulating RAUCLIMATE SILENT BREEZE fan coils can be made for each room.

**07.05.01 Basic Settings**



Depending on the room configuration, different displays appear on the room page:

**A) Room without fan coil**

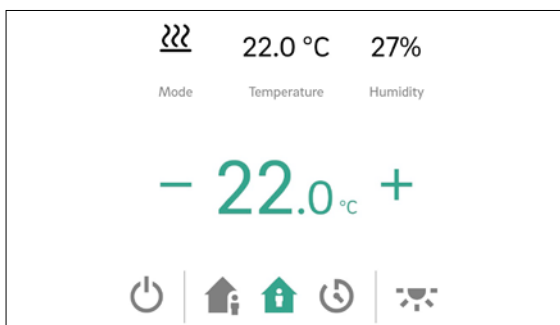

**B) Room with switched fan coil**

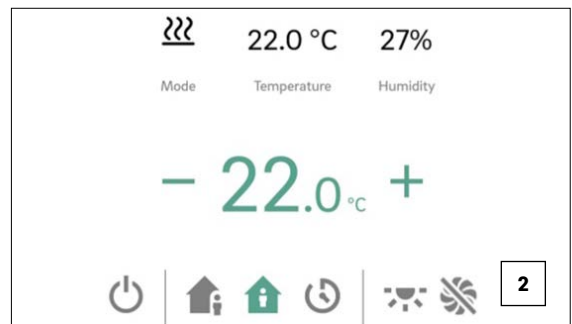
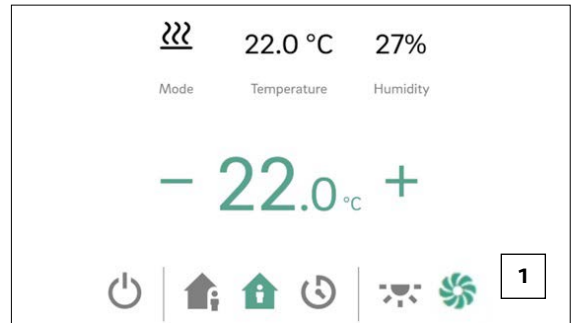
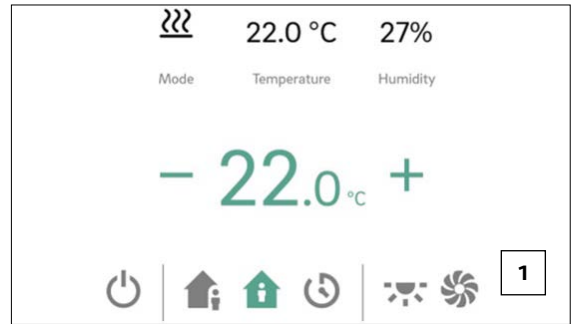

1 The „Fan Coil Icon” button can be used to manually start and stop the switched fan coil. The button indicates the operating status (green = fan coil in operation).

2 A crossed-out “Fan Coil Icon” button indicates that the switched fan foil is permanently disabled (turned off). Activation / deactivation is done via the Enabled / Deactivated button in the advanced settings or via the room unit (fan coil on / off).

**C) Room with modulating RAUCLIMATE SILENT BREEZE fan coils also in combination with one switched fan coil**

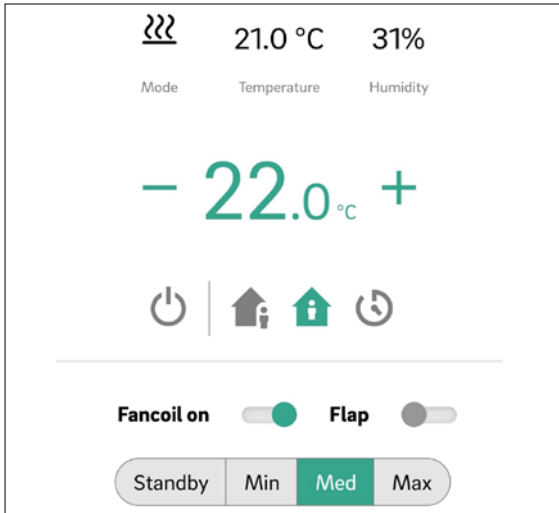

- Change fan coil operating mode (OFF, STANDBY, MIN, MED, MAX)

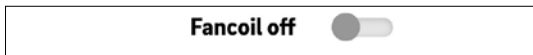

When the fan coil is switched off, the setting options for operating mode and fan flap are hidden.

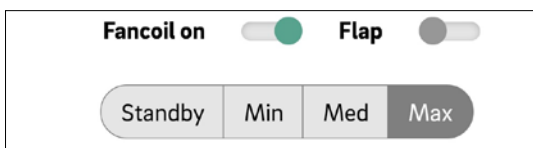
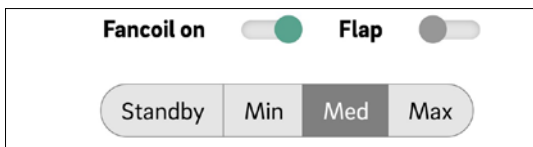
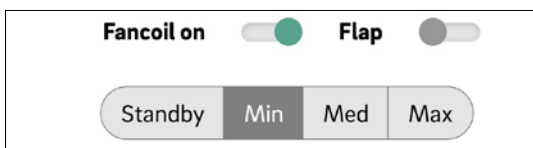
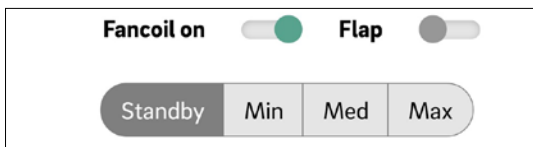

- Display fan foil operating status (green = Fan coil in operation)

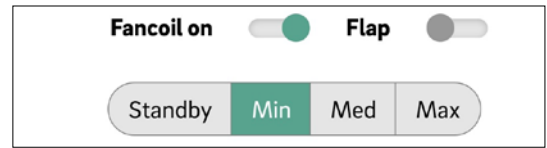

- Activation of the fan foil flap (grey = Off / green = On) to switch between oscillating and directional airflow when using a RAUCLIMATE SILENT BREEZE fan coil with fan flap

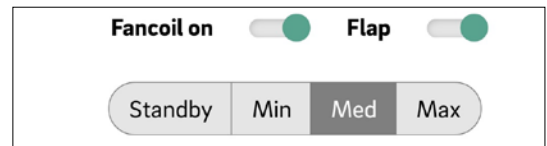
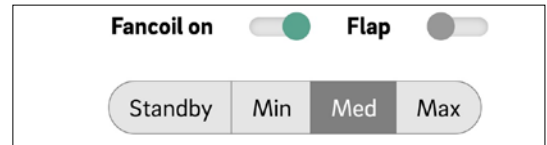

Switched fan coils and RAUCLIMATE SILENT BREEZE fan coils are in the setting

- Fancoil OFF permanently disabled
- STANDBY deactivated until the next switching point of a time program arrives or the energy level is manually changed. In this case the default setting for energy level REDUCED / NORMAL is applied.

RAUCLIMATE SILENT BREEZE fan coils are in the setting

- MIN / MED / MAX operated in the selected mode until the next switching point of a time program arrives or the energy level is manually changed. In this case the default setting for energy level REDUCED / NORMAL is applied.

Without the use of timers, the fan coil remains in the selected energy level.

07.05.02 Advanced Settings

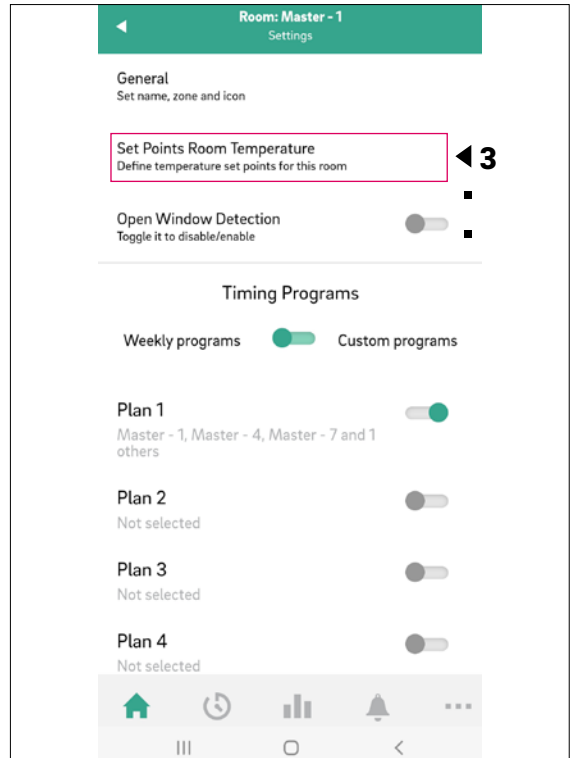
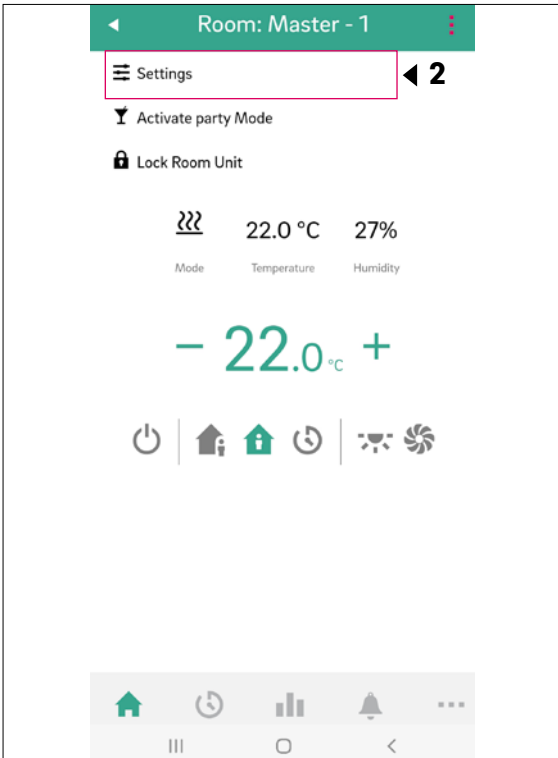
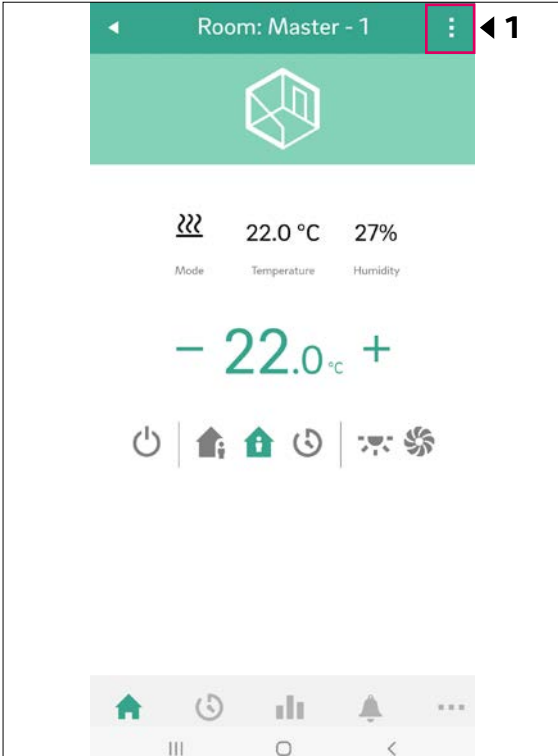

Depending on the room configuration, different setting options appear on the room page:

A) Advanced settings for switched fan coils

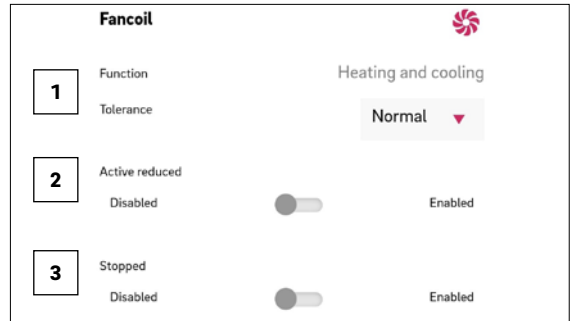

1 Selection fan coil tolerance: ECO, NORMAL, COMFORT

Fan coil starts when the room temperature deviates from the set point at ECO 1.5 K / NORMAL 1 K / COMFORT 0.5 K.

2 Active Reduced to enable / deactivate switched fan coils in REDUCED operation.

- Enabled: Switched fan coil is activated in NORMAL and REDUCED mode
- Disabled: Switched fan coil is activated in NORMAL mode and permanently switched off in REDUCED mode

3 Fan coil stopped (Enabled / Disabled) for permanent deactivation of switched fan coils.



**B) Advanced settings for modulating  
RAUCLIMATE SILENT BREEZE fan coils also in  
combination with one switched fan coil**

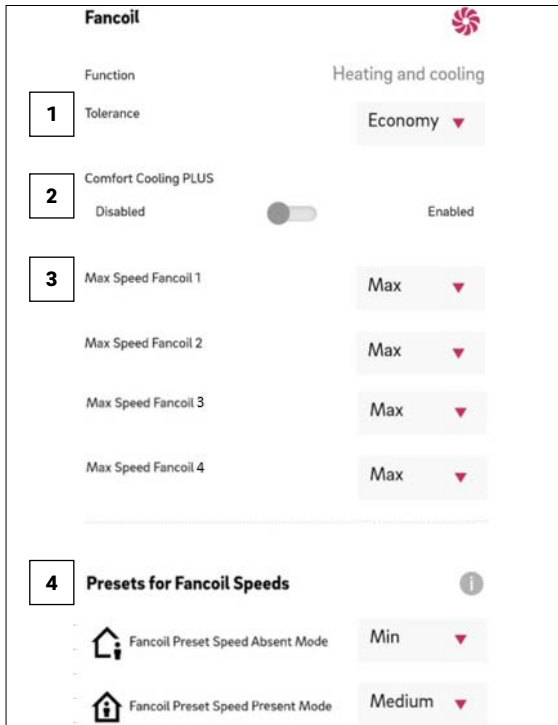

1 Tolerance: Selection fan coil tolerance: ECO, NORMAL, COMFORT.  
Fan coil starts when the room temperature deviates from the set point at ECO 1.5 K / NORMAL 1 K / COMFORT 0.5 K.

2 Comfort Cooling PLUS:  
Activation of COMFORT COOLING Plus to increase comfort in unpleasantly high humidity conditions for RAUCLIMATE SILENT BREEZE fan coils.

3 Max Speed Fancoil: Selection of the maximum possible air speed (MIN, MED, MAX) for RAUCLIMATE SILENT BREEZE fan coils.  
The RAUCLIMATE SILENT BREEZE fan coils assigned to the room are listed individually (maximum 4) and can be individually adapted.

4 Presets for Fancoil Speeds:  
Preset of the fan speed stage (STANDBY, MIN, MED, MAX) in energy level REDUCED (Absent Mode) and NORMAL (Present Mode) for RAUCLIMATE SILENT BREEZE fan coils.



If STANDBY is selected under presets (default settings), switched fan coils and RAUCLIMATE SILENT BREEZE fan coils are deactivated in REDUCED and / or NORMAL operation in the basic state. This setting can be temporarily overridden on the main room page.

07.05.03 App Pages using Example Configurations

Room Master-4

Configuration:

- 1 x Switched fan coil

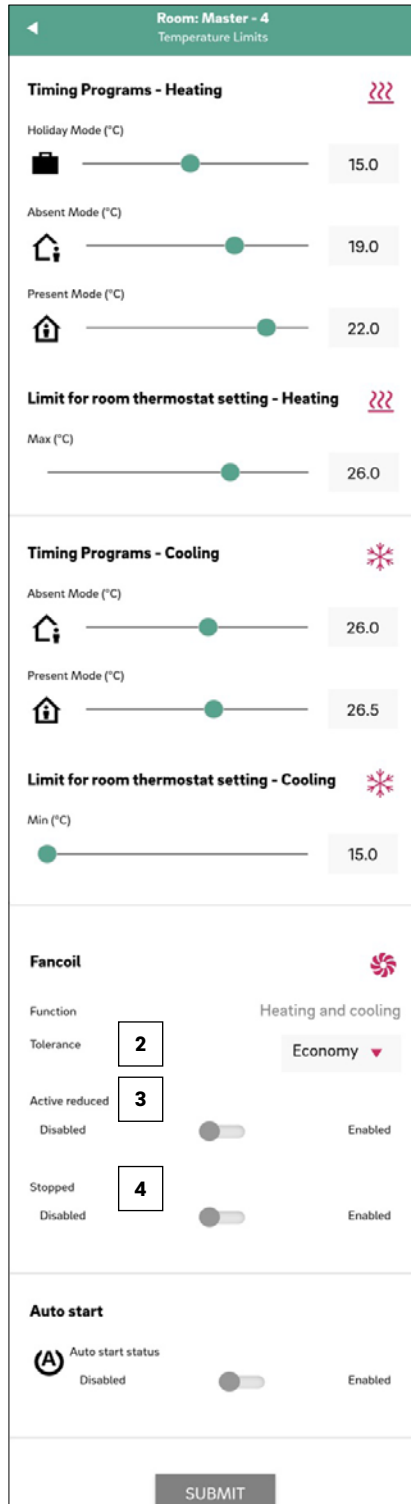
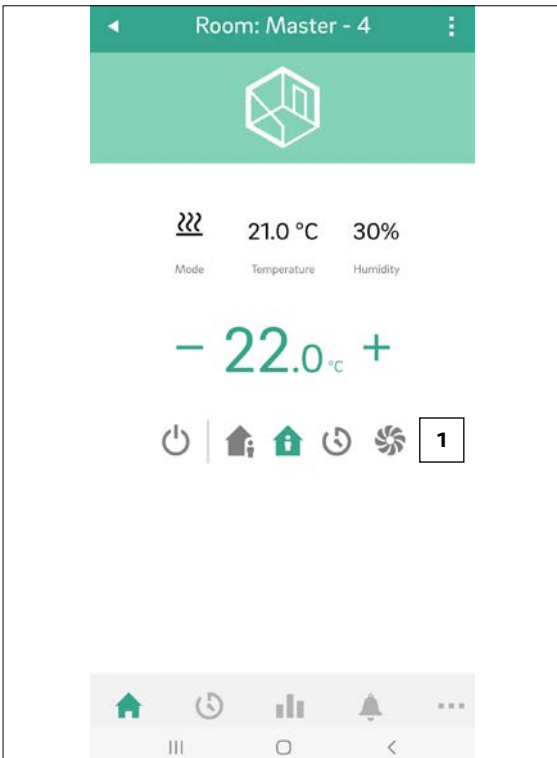

1 Change / Display Fan Coil Operation Mode

2 Selection Fan Coil Tolerance (ECO, NORMAL, COMFORT)

3 Active Reduced for activating / deactivating switched fan coils in REDUCED operation, when there is only a switched fan coil assigned to the room

4 Fan coil stopped to activate / deactivate switched fan coils

**Room Master-7**

Configuration:

- 1 x Switched fan coil
- 1 x RAUCLIMATE SILENT BREEZE fan coil

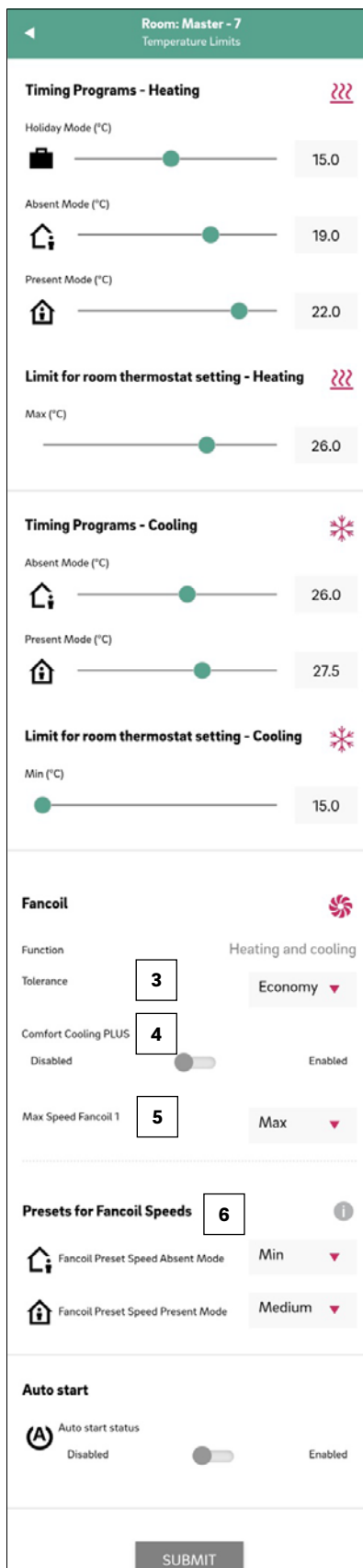
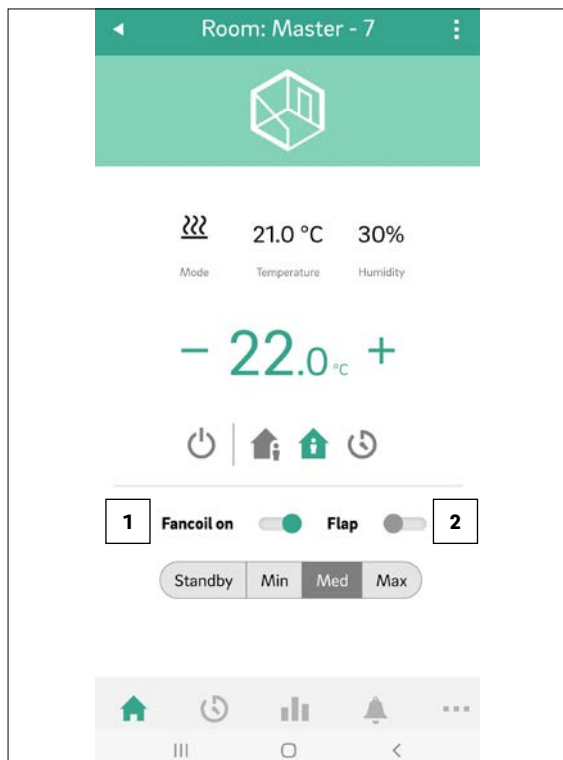

1 Change / display of the **fan coil operating mode** (OFF, STANDBY, MIN, MED, MAX)

2 Activation of the **Fan Coil Flap** (On / Off) to switch between oscillating and directional airflow. Displayed only for fan coils with flap control).

3 Selection **Fan Coil Tolerance** (ECO, NORMAL, COMFORT)

4 Activation **Comfort Cooling PLUS** for RAUCLIMATE SILENT BREEZE fan coils

5 Selection of the maximum possible air speed **Max speed Fancoil** (MIN, MED, MAX) for RAUCLIMATE SILENT BREEZE fan coils

6 Presetting of the fan speed stage (STANDBY, MIN, MED, MAX) in the energy level **REDUCED** and **NORMAL** for RAUCLIMATE SILENT BREEZE fan coils

**Room Master-10**

Configuration:

- 2 x RAUCLIMATE SILENT BREEZE Fan Coils

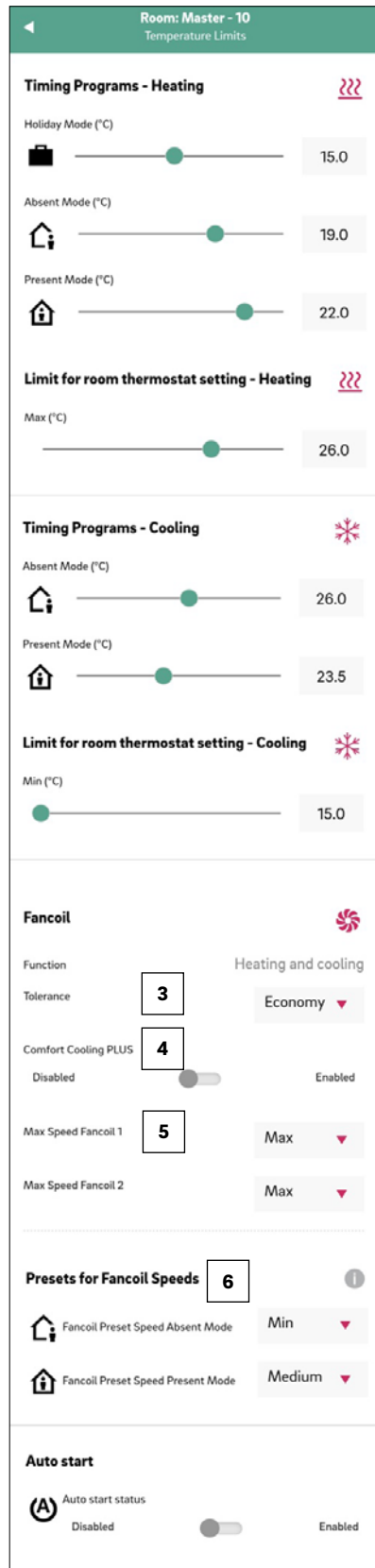
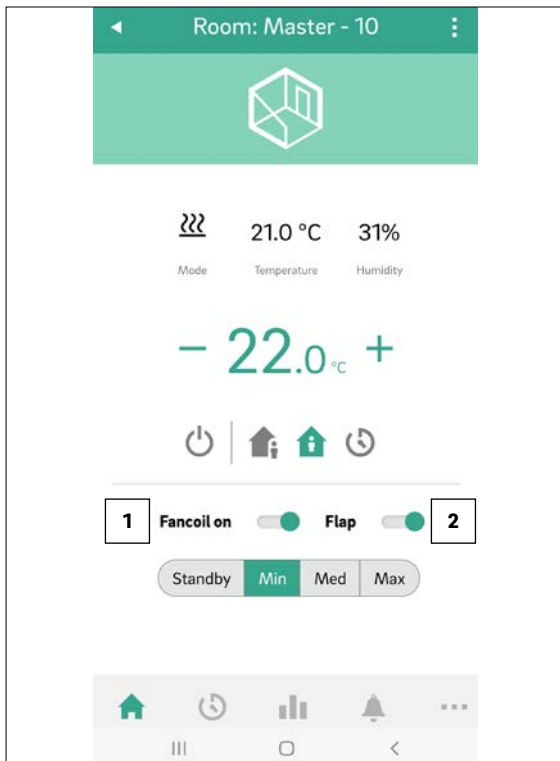

1 Change / display of the **fan coil operating mode** (OFF, STANDBY, MIN, MED, MAX)

2 Activation of the **Fan Coil Flap** (On / Off) to switch between oscillating and directional airflow. Displayed only for fan coils with flap control.

3 Selection **Fan Coil Tolerance** (ECO, NORMAL, COMFORT)

4 Activation **Comfort Cooling PLUS** for RAUCLIMATE SILENT BREEZE fan coils

5 Selection of the maximum possible air speed **Max speed Fancoil** (MIN, MED, MAX) for RAUCLIMATE SILENT BREEZE fan coils No. 1 and fan coil No. 2

6 Presetting of the fan speed stage (STANDBY, MIN, MED, MAX) in the energy level **REDUCED** and **NORMAL** for RAUCLIMATE SILENT BREEZE fan coils

## 08 Battery (battery-operated thermostat only)

### Changing the batteries

If you have opted for a wireless room unit or wireless room probe the battery status is displayed:

- in the App and on the web pages (room pages) by a battery status indicator individually for each room unit or room probe
- on the room unit by a warning message symbol "battery low"
- on the room probe by a LED blink code (blink every 5 minutes) which symbols battery low

Replace the batteries, if the service life of the batteries comes to an end.

To do so, open the housing of the NEA SMART 2.0 Room unit or NEA SMART 2.0 Room probe (see Fig. 08-1) with a screwdriver (recommended width: 5 mm).

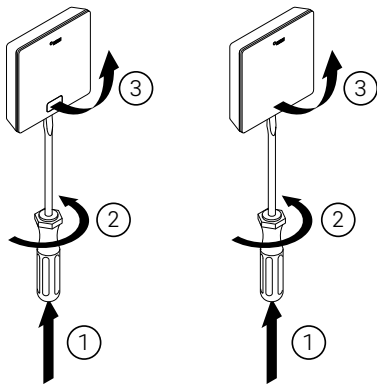

Fig. 08-1 Opening the NEA SMART 2.0 Room unit / NEA SMART 2.0 Room probe

Remove the batteries from the compartment and insert new batteries. Ensure correct polarity! See imprint on the circuit board.



Use two batteries type AAA 1.5 V Micro LR03. Rechargeable batteries may not be used.

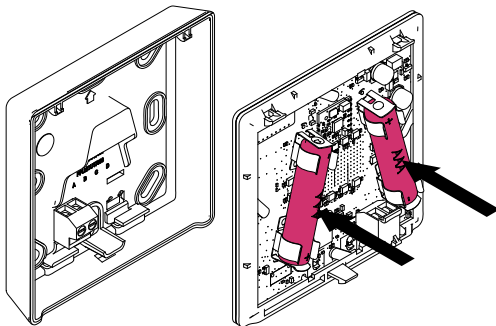

Fig. 08-2 NEA SMART 2.0 Room unit / NEA SMART 2.0 Room probe – battery change

Afterwards, close the lid again.

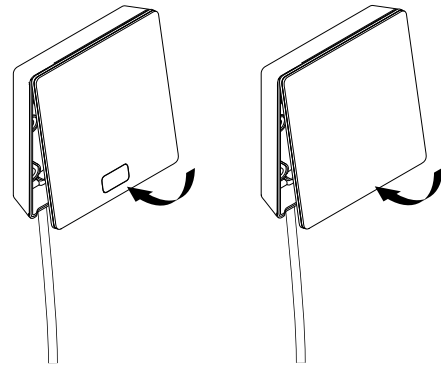

Fig. 08-3 NEA SMART 2.0 Room unit / NEASmart 2.0 Room probe close the lid



Depending on the installation location and the frequency of use, a battery change of the wireless room unit or room probes is necessary Approximately every 2 years.

An indication for the upcoming battery change is shown on the display of the room unit and room probe as well as in the App and on the web pages.

## 09 Error description

### 09.01 NEA SMART 2.0 Room unit

#### Error messages

The following error messages can be displayed on the Room unit. For resolving these issues, please contact your installer.

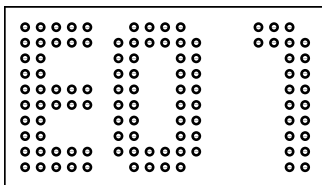

- E 01** Room temperature outside the measuring range
- E 02** Room temperature sensor defective (interruption)
- E 03** Short-circuit room temperature sensor
- E 04** Humidity outside the measuring range
- E 05** Humidity sensor defective (interruption)
- E 06** Short-circuit humidity sensor
- E 07** Remote sensor temperature outside the measuring range
- E 08** Remote sensor defective (interruption), check connecting lead
- E 09** Short-circuit remote sensor, check connecting lead
- E 10** Connection error between base station and R- / U-Module
- E 50** RAUCLIMATE SILENT BREEZE fan coils: Communication error between base and fan coil
- E 51** RAUCLIMATE SILENT BREEZE fan coils: Motor fault
- E 52** RAUCLIMATE SILENT BREEZE fan coils: Fan Coil Stop – difference between air and T2 water temperature too large
- E 53** RAUCLIMATE SILENT BREEZE fan coils: Sensor T2 water temperature defective (short-circuit / interruption)
- E 54** RAUCLIMATE SILENT BREEZE fan coils: T2 Water temperature too cold for heating or too warm for cooling
- E 56** RAUCLIMATE SILENT BREEZE fan coils: Fan Coil in fault mode
- E 90** Communication error between Base and several R-Modules
- E 99** Reference to a message that is only displayed on the NEA SMART 2.0 App

### 09.02 NEA SMART 2.0 Room probe

#### Error messages

The following error messages can be displayed on the room probe via a LED blink code.

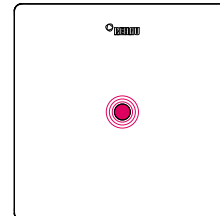

Battery low (blink every 5 minutes)



Connection to Base lost (blink every 15 minutes)



Room temperature sensor defective (interruption) – internal and / or external



Humidity sensor defective (interruption)



General error (antifreeze, dew point, open window)

### 09.03 Faults and possible causes

#### The room does not get warm.

- The target temperature is set too low.
- A window is open and therefore the heating has switched to reduced mode.
- The battery of the thermostat is empty. Therefore, no data / commands can be sent to the system.
- In the bus version, the power supply may be interrupted, so there is no contact to the system.
- The heating system is not in heating mode or OFF.
- Other fault which can only be fixed by your installer.

#### The room is too hot

- The target temperature is set too high. Therefore, the system continues to heat up.

#### The room unit does not respond to buttons being pressed

- The battery is empty. Please replace the batteries.
- The room unit is defective; please notify the installer.
- The power supply may be interrupted in the bus version.

**An antenna symbol is displayed on the thermostat.**

- The Room unit has lost its connection to the Base. Please let your installer clarify the problem. It may be necessary to use an additional antenna.

**A window is shown on the display**

- An open window or a rapid temperature drop has been recognized in the room. To conserve energy, the heating of the room is reduced.

**Drops are shown on the display**

- The humidity in the room is very high. There is a risk of condensate forming on cold surfaces. If this occurs often, there is a risk of mould growth.

**E01 ... E99 is displayed on the room unit**

- This is an error code, please check the error list and contact the installer if required.

# 10 Technical data NEA SMART 2.0

## 10.01 NEA SMART 2.0 Room unit

The NEA SMART 2.0 Room unit's functional features are indicated by a suffix, such as TRW or HRB. The following naming system is used:

NEA SMART 2.0 Room unit XXX

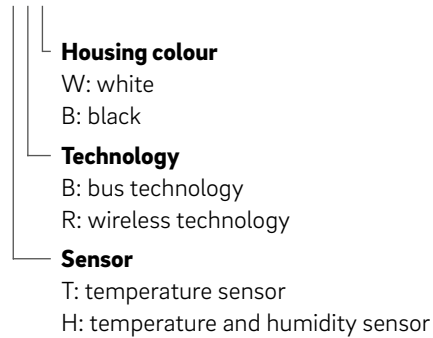

### Features on the available variants

Room unit NEA SMART 2.0	Temperature	Temperature and humidity	Wired	Wireless	Housing, white	Housing, black	Illuminated frame
TBW	X		X		X		X
HBW		X	X		X		X
HBB		X	X			X	X
TRW	X			X	X		
HRW		X		X	X		
HRB		X		X		X	

Functional features on the NEA SMART 2.0 Room unit variants

Power supply (bus technology, variant XBX)	Via zone bus (ZOBUS)
Power supply (wireless technology, variant XRX)	2 x LR03 AAA alkaline batteries, battery life of two years
Analogue input	NTC 10 K for external temperature sensor NEA SMART 2.0 Remote sensor or NEA SMART 2.0 VL / RL sensor; Window contact; Dew point sensor
Precision of temperature measurement	±1 K in the range 0 °C to 45 °C
Temperature measurement range	-10 °C to 45 °C (displayed: 0 °C to 45 °C)
Precision of humidity measurement; measurement range (variants HXX)	±3 % in the range 20 – 80 % at 20 °C, ±5 % outside this range; 0 ... 100 %
Protection class/protection rating	III/IP20
CE conformity as per	EN 60730
Dimensions (W x H x D in mm)	86 x 86 x 21
Housing material	ABS/PC
Housing colour (variants XXW)	White (similar to RAL 9003)
Housing colour (variants XXB)	Black (RAL 9011)
Weight	0.077 kg
Ambient temperature	0 °C to +50 °C
Ambient humidity	< 95 % r. m., non-condensing
Storage / transport temperature	-25 °C to +60 °C
Usage environment	Indoors only



## 10.02 NEA SMART 2.0 Room probe

The NEA SMART 2.0 Room probe's features are indicated by a suffix, such as TBW or HBW. The following naming system is used:

NEA SMART 2.0 Room probe XXX

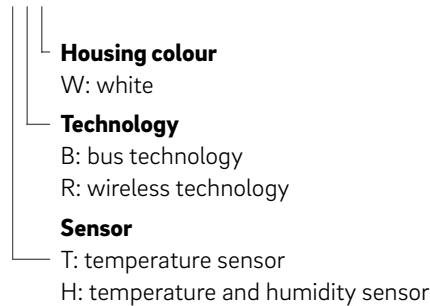

### Features on the available variants

NEA SMART 2.0 Room probe	Temperature	Temperature and humidity	Wired	Wireless	Housing, white
TBW	X		X		X
HBW		X	X		X
TRW	X			X	X
HRW		X		X	X

Functional features of the NEA SMART 2.0 Room probe

Power supply (bus technology, variant XBX)	Via zone bus (ZOBUS)
Power supply (wireless technology, variant XRX)	2 x LR03 AAA alkaline batteries, battery life of two years
Analogue input	NTC 10 K for external temperature sensor NEA SMART 2.0 Remote sensor or NEA SMART 2.0 VL / RL sensor; Window contact; Dew point sensor
Precision of temperature measurement	±1K in the range 0 °C to 45 °C
Temperature measurement range	-10 °C to 45 °C (displayed: 0 °C to 45 °C)
Precision of humidity measurement; measurement range (variants HXX)	±3 % in the range 20 – 80 % at 20 °C, ±5 % outside this range; 0 ... 100 %
Protection class/protection rating	III/IP20
CE conformity as per	EN 60730
Dimensions (W x H x D in mm)	86 x 86 x 21
Housing material	ABS/PC
Housing colour (variants XXW)	White (similar to RAL 9003)
Weight	0.077 kg
Ambient temperature	0 °C to +50 °C
Ambient humidity	< 95 % r. m., non-condensing
Storage/transport temperature	-25 °C to +60 °C
Usage environment	Indoors only

**10.03 Base****10.03.01 NEA SMART 2.0 Base 24 V**

Power supply	24 V AC $\pm$ 15 %/50 Hz
Power consumption	3 W (without thermal actuators, without R-Module and U-Module)
Digital outputs	8 triac outputs for REHAU actuators, switching capacity 1 A non-inductive, 24 VAC, maximum load per output: 4 REHAU 24 V actuators 4 relay outputs (potential-free contacts) 230 V, 5 A, Class II
Fuse	T2A
Digital inputs	4 inputs for potential-free contacts
Radio frequency	869 MHz; 2,4 GHz
Radio range	869 MHz: 100 m outdoors, 25 m in buildings (typical)
Bus system 1	Zone bus (ZOBUS): 2-wire bus system; no need to take polarity into account; maximum length 100 m; no shielded or twisted pair cable required
Bus system 2	System bus (SYSBUS): 3-wire RS-485 bus system; maximum length 500 m; shielded or twisted wire pair cable required
Protection class/protection rating	II/IP20
CE conformity as per	EN 60730
Dimensions (W x H x D in mm)	317 x 83.5 x 52.6
Housing material	ABS/PC
Housing colour	White (similar to RAL 9003)
Weight	0.535 kg
Ambient temperature	0 °C to +50 °C
Ambient humidity	< 95 % r. m., non-condensing
Storage/transport temperature	-25 °C to +60 °C
Usage environment	Indoors only

**10.03.02 NEA SMART 2.0 Base 230 V**

Power supply	230 V AC $\pm 15\%$ /50 Hz
Power consumption	3.5 W (without thermal actuators, without R-Module and U-Module)
Digital outputs	8 triac outputs for REHAU actuators, switching capacity 0.5 A non-inductive, 230 V AC, maximum load per output: 4 REHAU 230 V actuators 4 relay outputs (potential-free contacts) 230 V, 5 A, Class II
Fuse	T2A 5 x 20 mm
Digital inputs	4 inputs for potential-free contacts
Radio frequency	869 MHz; 2,4 GHz
Radio range	869 MHz: 100 m outdoors, 25 m in buildings (typical)
Bus system 1	Zone bus (ZOBUS): 2-wire bus system; no need to take polarity into account; maximum length 100 m; no shielded or twisted pair cable required
Bus system 2	System bus (SYSBUS): 3-wire RS-485 bus system; maximum length 500 m; shielded or twisted wire pair cable required
Protection class/protection rating	II/IP20
CE conformity as per	EN 60730
Dimensions (W x H x D in mm)	317 x 83.5 x 52.6
Housing material	ABS/PC
Housing colour	White (similar to RAL 9003)
Weight	0.65 kg
Ambient temperature	0 °C to +50 °C
Ambient humidity	< 95 % r. m., non-condensing
Storage/transport temperature	-25 °C to +60 °C
Usage environment	Indoors only

**10.04 Extension modules****10.04.01 NEA SMART 2.0 R-Module 24 V**

Power supply	Via ZOBUS (from NEA SMART 2.0 Base 24 V)
Power supply for thermal actuators	24 V AC $\pm 15\%$ /50 Hz
Digital outputs	4 triac outputs for REHAU actuators, switching capacity 1 A non-inductive, 24 VAC, maximum load per output: 4 REHAU 24 V actuators 2 relay outputs (potential-free contacts) 230 V, 5 A, Class II
Fuse	T2A
Digital inputs	1 input for potential-free contact
Bus system	Zone bus (ZOBUS): 2-wire bus system; no need to take polarity into account; maximum length 100 m; no shielded or twisted pair cable required
Protection class/protection rating	II/IP20
CE conformity as per	EN 60730
Dimensions (W x H x D in mm)	125.5 x 83.5 x 52.6
Housing material	ABS/PC
Housing colour	White (similar to RAL 9003)
Weight	0.235 kg
Ambient temperature	0 °C to +50 °C
Ambient humidity	< 95 % r. m., non-condensing
Storage/transport temperature	-25 °C to +60 °C
Usage environment	Indoors only

**10.04.02 NEA SMART 2.0 R-Module 230 V**

Power supply	Via ZOBUS (from NEA SMART 2.0 Base 24 V)
Power supply for thermal actuators	230 V AC $\pm 15\%$ /50 Hz
Digital outputs	4 triac outputs for REHAU actuators, switching capacity 0.5 A non-inductive, 230 VAC, maximum load per output: 4 REHAU 230 V actuators 2 relay outputs (potential-free contacts) 230 V, 5 A, Class II
Fuse	T2A
Digital inputs	1 input for potential-free contact
Bus system	Zone bus (ZOBUS): 2-wire bus system; no need to take polarity into account; maximum length 100 m; no shielded or twisted pair cable required
Protection class/protection rating	II/IP20
CE conformity as per	EN 60730
Dimensions (W x H x D in mm)	125.5 x 83.5 x 52.6
Housing material	ABS/PC
Housing colour	White (similar to RAL 9003)
Weight	0.260 kg
Ambient temperature	0 °C to +50 °C
Ambient humidity	< 95 % r. m., non-condensing
Storage/transport temperature	-25 °C to +60 °C
Usage environment	Indoors only

**10.04.03 NEA SMART 2.0 U-Module 24 V**

Power supply	SYSBUS (from NEA SMART 2.0 Base 230 V or NEA SMART 2.0 Base 24 V)
Additional power supply	24 V AC $\pm 15\%$ /50 Hz (required for analogue output 0 ... 10 V output)
Digital outputs	4 relay outputs (potential-free contacts) 230 V, 5 A, Class II
Digital inputs	4 inputs for potential-free contact
Analogue inputs	AI1, AI2, AI3: NTC 10 K AI4: ---
Analogue outputs	1 output 0 ... 10 V
Bus system	System bus (SYSBUS): 3-wire RS-485 bus system; maximum total length of the bus line 500 m; shielded or twisted wire pair cable required
Protection class/protection rating	II/IP20
CE conformity as per	EN 60730
Dimensions (W x H x D in mm)	125.5 x 83.5 x 52.6
Housing material	ABS/PC
Housing colour	White (similar to RAL 9003)
Weight	0.235 kg
Ambient temperature	0 °C to +50 °C
Ambient humidity	< 95 % r. m., non-condensing
Storage/transport temperature	-25 °C to +60 °C
Usage environment	Indoors only

**10.05 Accessories****10.05.01 NEA SMART 2.0 Transformer**

Primary voltage	230 V AC $\pm$ 15 %/50 Hz
Secondary voltage	24 V AC $\pm$ 15 %/50 Hz
Performance	60 VA
Power loss when idle	< 2.5 W
Integrated fuse	Thermal fuse @130 °C
Protection class/protection rating	II/IP20
CE conformity as per	EN 61558
Dimensions (W x H x D in mm)	94 x 83.5 x 66.4 mm
Housing material	ABS
Housing colour	White (similar to RAL 9003)
Weight	1.8 kg
Ambient temperature	-25 °C to +50 °C
Ambient humidity	< 95 % r. m., non-condensing
Storage/transport temperature	-25 °C to +60 °C
Usage environment	Indoors only

**10.05.02 NEA SMART 2.0 Outdoor sensor**

Power supply	1 x LR06 (AA) lithium battery 3.6 V
Radio frequency	869 MHz
Radio range	180 m outdoors, 30 m in buildings (typical)
Precision of temperature measurement	$\pm$ 0.5 K in the temperature range 15 to 30 °C
Temperature measuring range	-20 °C to +50 °C
Protection class/protection rating	III/IP45
CE conformity as per	EN 60730
Dimensions (W x H x D in mm)	79.6 x 79.6 x 49
Housing material	ABS
Housing colour	White
Weight	0.114 kg (including battery)
Ambient temperature	-50 °C to +65 °C
Ambient humidity	< 95 % r. m., non-condensing
Storage/transport temperature	-25 °C to +60 °C

**10.05.03 NEA SMART 2.0 Remote sensor**

Sensor type	NTC 10 K
Precision	±5 % @25 °C
Protection rating	IP67
CE conformity as per	EN 60730
Sensor element dimensions (W x H x D in mm)	28 x 6 x 6
Cable length	3 m
Housing material	Sensor sheathing: PBT; cable sheathing: PVC (UL2517)
Housing colour	White (similar to RAL 9003)
Weight	0.065 kg
Ambient temperature	-20 °C to +60 °C
Ambient humidity	< 95 % r. m., non-condensing
Storage/transport temperature	-25 °C to +60 °C
Usage environment	Indoors only

**10.05.04 NEA SMART 2.0 VL / RL sensor**

Sensor type	NTC 10 K
Precision	±5 % @25 °C
Protection rating	IP67
CE conformity as per	EN 60730
Sensor element dimensions (W x H x D in mm)	45 x 5 x 5
Cable length	3 m
Housing material	Sensor sheathing: Metal; cable sheathing: PVC (UL2517)
Housing colour	White (similar to RAL 9003)
Weight	0.065 kg
Ambient temperature	-20 °C to +60 °C
Ambient humidity	< 95 % r. m., non-condensing
Storage/transport temperature	-25 °C to +60 °C
Usage environment	Indoors only

**10.05.05 NEA SMART 2.0 Antenna**

Power supply	From NEA SMART 2.0 Base
Radio frequency	869 MHz
Radio range	25 m in buildings
Protection class/protection rating	III/IP30
CE conformity as per	EN 60730
Dimensions (W x H x D in mm)	186 x 22 x 11
Housing material	PVC
Housing colour	White (similar to RAL 9010)
Weight	0.060 kg
Ambient temperature	0 °C to +50 °C
Ambient humidity	< 95 % r. m., non-condensing
Storage/transport temperature	-25 °C to +60 °C
Usage environment	Indoors only

**10.05.06 Thermal actuator UNI 24 V**

Operating voltage	24 V AC/DC, +20 % ... -10 %, 0 – 60 Hz
Operating output	1 W
Inrush peak current	≤ 300 mA @ 120 s
Actuating range	5.0 mm
Actuating force	100 N ±10 %
Protection class/protection rating	III / IP54
CE conformity as per	EN 60730
Dimensions (W x H x D in mm)	39 x 53 (+8) x 50
Cable length	1 m
Housing material	Polyamide
Housing colour	Light grey (RAL 7035)
Weight	0.105 kg
Ambient temperature	0 °C to +60 °C
Storage/transport temperature	-25 °C to +60 °C
Usage environment	Indoors only

**10.05.07 Thermal actuator UNI 230 V**

Operating voltage	230 V AC +10 % ... -10 %, 50/60 V
Operating output	1 W
Inrush peak current	≤ 375 mA @ 100 ms
Actuating range	5.0 mm
Actuating force	100 N ±10 %
Protection class/protection rating	II/IP54
CE conformity as per	EN 60730
Dimensions (W x H x D in mm)	39 x 53 (+8) x 50
Cable length	1 m
Housing material	Polyamide
Housing colour	Light grey (RAL 7035)
Weight	0.105 kg
Ambient temperature	0 °C to +60 °C
Storage/transport temperature	-25 °C to +60 °C
Usage environment	Indoors only



**10.05.08 NEA SMART 2.0 KNX Gateway**

KNX operating voltage	KNX nominal voltage 30 V DC
KNX bus current consumption	approx. 4 mA
Auxiliary voltage Modbus / SYSBUS	12 ... 24 V DC
Current consumption Modbus / SYSBUS	ca. 5 mA
Installation	DIN rails installation: Mounting rail
Housing	DIN series installation with 1 HP (18 mm)
Operating elements	2 buttons and 1 KNX programming button
Indicators	3 LEDs, multi-colour and programming LED (red)
Connector for KNX Bus	Red / black
Connector for Modbus / SYSBUS	Pluggable screw connector (3 poles) for Modbus
Connector for Modbus / SYSBUS auxiliary voltage	Pluggable screw connector (3 poles) for power supply
Cross-section of connectors	0.34 ... 2.5 mm <sup>2</sup>
Modbus / SYSBUS	Type: RTU (RS-485), Slave / Up to 250 channels
Degree of protection (acc. EN 60529)	IP 20
CE conformity / standards	EMC directive 2014 / 30 / EU RoHS directive 2011 / 65 / EU EN 50491-3: 2009 EN 50491-5-1: 2010 EN 50491-5-2: 2010 EN 50491-5-3: 2010 EN 61000-6-2: 2005 EN 61000-6-3: 2007 + A1: 2011 EN 50581: 2012
Dimensions (W x H x D in mm)	17.5 x 59.8 x 89.8
Housing material	Cover: PC Base plate: PA 66/6
Housing colour	Cover: Light grey RAL 7035 Base plate: Graphite black RAL 9011
Weight	50 g
Ambient temperature	-5 °C to +45 °C
Storage temperature	-25 °C to +70 °C
Ambient humidity	5 % to 93 % r.m., non-condensing
Usage environment	Indoors only

**10.05.09 NEA SMART 2.0 Power supply gateway**

Operating voltage	85 V to 264 V AC
Frequency range	47 – 63 Hz
Current consumption	0.25 A / 230 V AC
Inrush current, max.	45 A / 230 V AC
Efficiency	85 %
Output voltage	12 V DC
Output voltage – Adjustment range	10.8 V DC to 13.8 V DC
Output current	0 to 1.25 A
Output power	15 W
Type	Switch Mode
Operating time max.	1166000 h
Ripple	120 mV ss
Load regulation	1 %
Installation	DIN rails installation: 1 HP; mounting rail TS-35/7.5 or TS-35/15
Operating elements	1 potentiometer
Indicator	1 LED (blue); Power-On
Special features	Short-circuit, overvoltage and overload protection
Cross-section of connectors	0.5 mm <sup>2</sup> to 2.5 mm <sup>2</sup>
Protection class / protection rating	II / no IP assigned
CE conformity / standards UL approval	RoHS-conform, EN 60950-1; EN 6155-2-16; EN50178; UL 508; UL 60950-1  EMC EN55032 (CISPR32) Class B; EN61000-3-2 Class A; EN61000-3-3; EN61000-4-2, -3, -4, -5, -6, -8, -11
Dimensions (W x H x D in mm)	17.5 x 93 x 58.4
Weight	78 g
Ambient temperature	-30 °C to +70 °C
Storage temperature	-40 °C to +85 °C
Ambient humidity	20 % to 90 % r.m., non-condensing
Storage humidity	10 % to 95 % r.m., non-condensing
Usage environment	Indoors only

**10.05.10 Coupling Relay 24 V / 230 V**

Coil voltage	24 V AC / 230 V AC
Contacts, maximum continuous current	8 A
Conformity	DIN VDE 0815, 2014/35/EU
Dimensions (W x H x D in mm)	18 x 62 x 75
Weight	70 g
Ambient temperature	-40 °C ... 85 °C
Usage environment	Indoors only

**10.05.11 Switching Relay 24 V / 230 V**

Coil voltage	24 V AC / 230 V AC
Contacts, maximum continuous current	25 A
Conformity	DIN VDE 0815, 2014/35/EU
Dimensions (W x H x D in mm)	18 x 62 x 85
Weight	88 g
Ambient temperature	-40 °C ... 85 °C
Usage environment	Indoors only

**10.05.12 NEA SMART 2.0 Bus Cable (10 / 50 m bundle)**

Cable type	J-Y(ST)Y 2 x 2 x 0.8 mm
Conformity	DIN EN 50441, VDE 0815
Loop resistance	max. 73.2 Ohm/km
Conductor cross-section	0.8 mm
Outer diameter	7 mm
Length	10 m / 50 m
Weight	6 kg per 100 m
Ambient temperature	-5 °C ... 50 °C
Usage environment	Indoors only

This document is protected by copyright. All rights based on this are reserved. No part of this publication may be translated, reproduced or transmitted in any form or by any similar means, electronic or mechanical, photocopying, recording or otherwise, or stored in a data retrieval system.

Our verbal and written advice with regard to usage is based on years of experience and standardised assumptions and is provided to the best of our knowledge. The intended use of REHAU products is described comprehensively in the technical product information. The latest version can be viewed at [www.rehau.com/TI](http://www.rehau.com/TI). We have no control over the application,

use or processing of the products. Responsibility for these activities therefore remains entirely with the respective user/processor. Where claims for liability nonetheless arise, they shall be governed exclusively according to our terms and conditions, available at [www.rehau.com/conditions](http://www.rehau.com/conditions), insofar as nothing else has been agreed upon with REHAU in writing. This shall also apply for all warranty claims, with the warranty applying to the consistent quality of our products in accordance with our specifications. Subject to technical changes.

[www.rehau.com](http://www.rehau.com)

© REHAU Industries SE & Co. KG  
Helmut-Wagner-Str. 1  
Rheniumhaus  
95111 Rehau

954641 EN 04.2024